


2002

# Current state and updating of heat and moisture production of poultry and their housing systems

Hakgamalang Justin Chepete  
*Iowa State University*

Follow this and additional works at: <https://lib.dr.iastate.edu/rtd>

 Part of the [Agriculture Commons](#), [Animal Sciences Commons](#), and the [Bioresource and Agricultural Engineering Commons](#)

---

## Recommended Citation

Chepete, Hakgamalang Justin, "Current state and updating of heat and moisture production of poultry and their housing systems " (2002). *Retrospective Theses and Dissertations*. 362.  
<https://lib.dr.iastate.edu/rtd/362>

This Dissertation is brought to you for free and open access by the Iowa State University Capstones, Theses and Dissertations at Iowa State University Digital Repository. It has been accepted for inclusion in Retrospective Theses and Dissertations by an authorized administrator of Iowa State University Digital Repository. For more information, please contact [digirep@iastate.edu](mailto:digirep@iastate.edu).

## **INFORMATION TO USERS**

**This manuscript has been reproduced from the microfilm master. UMI films the text directly from the original or copy submitted. Thus, some thesis and dissertation copies are in typewriter face, while others may be from any type of computer printer.**

**The quality of this reproduction is dependent upon the quality of the copy submitted. Broken or indistinct print, colored or poor quality illustrations and photographs, print bleedthrough, substandard margins, and improper alignment can adversely affect reproduction.**

**In the unlikely event that the author did not send UMI a complete manuscript and there are missing pages, these will be noted. Also, if unauthorized copyright material had to be removed, a note will indicate the deletion.**

**Oversize materials (e.g., maps, drawings, charts) are reproduced by sectioning the original, beginning at the upper left-hand corner and continuing from left to right in equal sections with small overlaps.**

**Photographs included in the original manuscript have been reproduced xerographically in this copy. Higher quality 6" x 9" black and white photographic prints are available for any photographs or illustrations appearing in this copy for an additional charge. Contact UMI directly to order.**

**ProQuest Information and Learning  
300 North Zeeb Road, Ann Arbor, MI 48106-1346 USA  
800-521-0600**

**UMI<sup>®</sup>**



**Current state and updating of heat and moisture production of  
poultry and their housing systems**

by

**Hakgamalang Justin Chepete**

A dissertation submitted to the graduate faculty  
in partial fulfillment of the requirements for the degree of

**DOCTOR OF PHILOSOPHY**

**Major: Agricultural Engineering (Agricultural Structures and Environment)**

**Program of Study Committee:  
Hongwei Xin, Major Professor  
Jay D. Harmon  
Steven J. Hoff  
Ron M. Nelson  
Yuhong Yang**

**Iowa State University**

**Ames, Iowa**

**2002**

**Copyright © Hakgamalang Justin Chepete, 2002. All rights reserved.**

UMI Number: 3051453

UMI<sup>®</sup>

---

UMI Microform 3051453

Copyright 2002 by ProQuest Information and Learning Company.

All rights reserved. This microform edition is protected against  
unauthorized copying under Title 17, United States Code.

---

ProQuest Information and Learning Company

300 North Zeeb Road

P.O. Box 1346

Ann Arbor, MI 48106-1346

**Graduate College  
Iowa State University**

**This is to certify that the doctoral dissertation of  
Hakgamalang Justin Chepete  
has met the dissertation requirements of Iowa State University**

Signature was redacted for privacy.

**Committee Member**

Signature was redacted for privacy.

**Committee Member**

Signature was redacted for privacy.

**Committee Member**

Signature was redacted for privacy.

**Committee Member**

Signature was redacted for privacy.

**Major Professor**

Signature was redacted for privacy.

**For the Major Program**

DEDICATION

To my parents, brothers and sisters,  
Whose support I value and whose love I treasure.

**TABLE OF CONTENTS**

<b>CHAPTER 1. GENERAL INTRODUCTION</b>	1
Overview	1
Factors That Influence HP and MP Rates	1
Measurement of HP and MP Rates	5
Iowa State University (ISU) Indirect Animal Calorimetry System	7
Care and Operation of the Indirect Calorimeters	11
Measurement of the Energetic Responses	12
Scope of Research	14
Study Objectives	15
Dissertation Organization	15
References	16
<b>CHAPTER 2. HEAT AND MOISTURE PRODUCTION OF POULTRY AND THEIR HOUSING SYSTEMS: <i>LITERATURE REVIEW</i></b>	22
Abstract	22
Introduction	23
Method of Data Collection and Presentation	24
Results and Discussion	25
Conclusions	29
Acknowledgement	30
References	30
<b>CHAPTER 3. HEAT AND MOISTURE PRODUCTION OF POULTRY AND THEIR HOUSING SYSTEMS: <i>PULLETS &amp; LAYERS</i></b>	54
Abstract	54
Introduction	55



Materials and Methods	56
Results and Discussion	59
Conclusions	67
Acknowledgements	69
References	69
<b>CHAPTER 4. HEAT AND MOISTURE PRODUCTION OF POULTRY AND THEIR HOUSING SYSTEMS: <i>MOLTING LAYERS</i></b>	<b>83</b>
Abstract	83
Introduction	84
Materials and Methods	85
Results and Discussion	87
Conclusions	94
Acknowledgements	95
References	96
<b>CHAPTER 5. HEAT AND MOISTURE PRODUCTION OF POULTRY AND THEIR HOUSING SYSTEMS: <i>AN APPLICATION IN BUILDING VENTILATION RATE DESIGN</i></b>	<b>113</b>
Abstract	113
Introduction	114
Materials and Methods	115
Results and Discussion	119
Conclusions	124
References	125
<b>CHAPTER 6. GENERAL CONCLUSIONS</b>	<b>136</b>
<b>APPENDIX 1. CR10 PROGRAM USED IN THE STUDY</b>	<b>139</b>

<b>APPENDIX 2. LINEAR FUNCTIONS OBTAINED FROM CALIBRATION OF INSTRUMENTS</b>	151
<b>APPENDIX 3. DYNAMIC BEHAVIOR OF DAILY CALIBRATION OF THE OXYGEN AND CARBON DIOXIDE GAS ANALYZERS DURING THE COURSE OF SOME TRIALS</b>	156
<b>APPENDIX 4. DYNAMIC PROFILES OF HEAT AND MOISTURE PRODUCTION OF PULLETS AND LAYERS DURING VARIOUS SELECTED TRIALS</b>	161
<b>ACKNOWLEDGEMENTS</b>	174

## **CHAPTER 1.**

### **GENERAL INTRODUCTION**

#### **Overview**

Hartung (1994) reported that heat and moisture production (HP and MP) rates directly affect the building temperature and relative humidity (RH) which in turn influence the concentration of aerial pollutants such as gases and bio-aerosols. To achieve animal comfort and optimum productivity, building temperature, moisture or RH, and aerial pollutants should be controlled and kept within suitable ranges through provision of adequate ventilation rates. The HP and MP rates are essential in determining the ventilation rates (Reece and Lott, 1982a; Reece and Deaton, 1971). The HP and MP data available in the literature are 20 to 50 years old (Chepete and Xin, 2002a). ASHRAE (2001), Xin et al. (1998), Gates et al. (1996), Reece and Lott (1982a,b) suggested a need to update the data in recognition of tremendous changes that have occurred through the years in animal genetics, nutrition, and housing management schemes. In response to the aforementioned concerns, a comprehensive review of literature was performed to document the current state of science in poultry HP and MP. More importantly, the HP and MP rates for modern laying hens and pullets, as well as laying hens during the molting stage, were measured and are presented in this study.

#### **Factors Influencing HP and MP Rates**

HP and MP rates of birds are influenced by, among others, breed, body temperature, ambient temperature, degree of activity, nutritional level, photoperiod, and body mass (M) (Deighton and Hutchinson, 1940). The following sections briefly describe such influences.

## **Breed**

Different breeds of chickens have different rates of HP, even when variations in their surface area and body mass are taken into account (Whittow, 1965). For instance, White Leghorns had higher HP than Rhode Island Reds which in turn produced more heat than did New Hampshire-Cornish cross birds (Ota and McNally, 1961).

Zulovich (1987) found that a layer pullet when housed at typical production temperatures had similar sensible heat loss to that of a broiler at the same body mass while the latent heat loss of the pullet was 50% that of the broiler.

## **Body Temperature (van't Hoff-Arrhenius effect)**

The rate of HP increases exponentially with increases in body temperature according to the equation

$$HP = HP_{TN} e^{k\Delta T_b}$$

$HP_{TN}$  is the HP within the thermoneutral zone;  $e$  is the base of the natural logarithms;  $k$  is the van't Hoff coefficient; and  $\Delta T_b$  is the increase in core body temperature. This equation demonstrates a logarithmic relation between HP and  $T_b$ . Other physiological properties such as heart rate are often related logarithmically to  $T_b$  (Whittow et al., 1964).

## **Ambient Temperature**

Ambient temperature influences the rate of heat loss (El Boushy and Marle, 1978; Reece and Lott, 1982b). If birds are kept in a cold environment for a prolonged period, their HP increases as they become acclimatized to cold, to a level from 20 to 40% higher than that before exposure to cold (Whittow, 1965). When the ambient temperature rises, it becomes more difficult for the birds to dissipate heat, which then alters the rate of HP (El Boushy and Marle, 1978). Acclimatization to heat by chickens results in a diminution of HP and this is

attributed to a decrease in the rate of secretion of thyroxine, a hormone known to stimulate metabolic activity (Huston et al., 1962; Heninger et al., 1960). Chwalibog and Eggum (1989) and Xin et al. (2001) reported that HP decreased with increasing ambient temperature. Further, Yuniato et al. (1997) stated that this decrease was linear up to 30°C. Chwalibog and Eggum (1989) further reported that evaporative heat loss increased with increasing ambient temperature.

### **Degree of Activity**

Activity undoubtedly brings about an increase in the metabolic rate. Standing alone can increase the HP of Light Sussex cocks by 40 to 50% (Deighton and Hutchinson, 1940). Through voluntary and involuntary means, a hen may easily vary its daily HP by as much as 15 to 25% (Longhouse et al., 1960). Even at rest, the birds generate heat by voluntary muscle activity and metabolic processes (North, 1972). Up to 25% of the HP is related to physical activity in laying hens (Boshouwers and Nicaise, 1985). The HP of birds during flight has been measured in the hummingbird and flight increased its HP to a value 6 or 7 times greater than that at rest (Pearson, 1950; Lasiewski, 1963).

### **Nutritional Level**

When birds are deprived of feed their HP diminishes. The respiratory quotient (RQ) decreases also because fat is preferentially metabolized during starvation (Koskemies, 1950). The rate of HP is higher in the fed than in the starved bird. In immature birds the difference is about 20%, and in the adults it may range from 25 to 68% (Meltzer, 1987). Energy restriction decreases metabolic rate since the latter is influenced by metabolizable energy (ME) concentration: with higher ME/kg the birds have higher metabolic rate. When chickens are fed a sufficient amount of feed to maintain constant body mass (maintenance diet), their HP

is about 50% greater than their standard metabolic rates (Mitchell, 1962). Brody (1945) defined the standard metabolic rate, also known as basal energy metabolism or post-absorptive metabolism, in two ways: as the heat production during complete rest in a TN environment in post-absorptive condition or as the resting energy metabolism in a TN environment uncomplicated by the heat increment of feeding. Some of the increased HP on a maintenance diet, over and above that of fasting birds, is the result of greater activity. A reduction of the dietary protein/energy ratio results in an increase in HP (Davidson, 1964) due to high energy content of the diet that will then increase the metabolic rate.

### **Photoperiod**

Light and darkness have been shown to have significant impact on the HP and MP rates of layers (Riskowski et al., 1977) and pullets (Zulovich et al., 1987). When birds were exposed to periods of light and dark, there was approximately a 20% (Riskowski et al., 1977), 35% (MacLeod and Jewitt, 1984), or 25 to 26% (Xin et al., 1996) reduction in HP of the birds from light to dark. The difference between the total heat loss during light and dark periods decreased with the decrease in the hours of light per day (Riskowski et al., 1977).

### **Body Mass**

Chepete and Xin (2002b) and Zulovich et al. (1987) observed an increase in HP with increasing M for layer chicks before reaching the metabolic peak and a decrease in HP with increasing M thereafter. This agreed with the findings by Longhouse et al. (1960) who reported that at constant temperature, specific HP of chickens (i.e. HP per unit body mass) decreased as body mass increased. The diminution in metabolic rate following the peak metabolic rate is possibly related to the development of a more effective insulation, so that

the need for an increased HP in order to maintain body temperature is lessened (Whittow, 1965).

### **Measurement of HP and MP Rates**

An animal in the basal state or in complete rest in a TN environment in post-absorptive condition, accomplishes little or no work in the physical sense (Brody, 1945; Dale, 1984). All of the energy released is degraded to heat and lost to the environment. Under these circumstances the intensity of energy metabolism can be estimated either by calculating HP from the exchange of respiratory gases (indirect calorimetry) or by measuring the heat which is lost from the body by radiation, conduction, convection, and evaporation (direct calorimetry) (Dale, 1984). In the absence of anaerobic, endothermic, and other unusual reactions in which the caloric equivalents of oxygen (O<sub>2</sub>) and carbon dioxide (CO<sub>2</sub>) are unknown, the results of the two methods are in substantial agreement (Brody, 1945).

#### **Direct Calorimetry**

Measurements of heat loss from the animal body include the sensible heat of radiation, conduction and convection and insensible or latent heat of water vaporized from the skin and the respiratory passages. Sensible heat loss from the animal can be measured with two general types of calorimeters, adiabatic and gradient. Evaporation of water from the animal body is estimated by determining the amount of water vapor added to the air that flows through the calorimeter. In practice, this method is much more expensive and complicated than the indirect method, and is thus not commonly used.

#### **Indirect Calorimetry**

Indirect calorimetry is based on the fact that normally the consumption of O<sub>2</sub> and the production of CO<sub>2</sub> are closely correlated with HP. In the oxidation of carbohydrates, the

volume of CO<sub>2</sub> produced is equal to the amount of O<sub>2</sub> consumed. This is illustrated as follows (Brody, 1945):

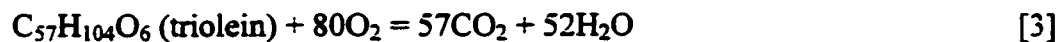


Thus, in the oxidation of 1 mole of C<sub>6</sub>H<sub>12</sub>O<sub>6</sub> weighing 180 grams, 6 moles of O<sub>2</sub> are consumed and 6 moles of CO<sub>2</sub> are produced. Since 1 mole of a gas at standard conditions has a volume of 22.4 liters, then there are 134.4 liters of O<sub>2</sub> consumed and of CO<sub>2</sub> produced. The calories produced per 1 gram of glucose are 3.74, and the use of 1 liter of O<sub>2</sub> in oxidizing glucose represents 5.047 calories. The caloric value of carbohydrates varies, depending on the type, but a value of 4.1 calories is considered an average for several types (Sturkie, 1954).

The non-protein RQ is the ratio of the volume of CO<sub>2</sub> produced to the volume of O<sub>2</sub> consumed:

$$\text{RQ} = \frac{\text{CO}_2}{\text{O}_2} \quad (\text{dimensionless}) \quad [2]$$

Thus, the RQ for carbohydrates is 1.00 and for fats it is less, because some of the O<sub>2</sub> is used in the oxidation of hydrogen as well as carbon. This is illustrated in the following equation:



$$\text{Then, RQ} = 57/80 = 0.71$$

The average RQ for mixed fats is 0.71. For mixed protein, the average RQ is about 0.80 for mammals and 0.705 for birds. In calculating the RQ of birds, the computations are based upon the heat of combustion of, and the amount of, uric acid in the urine (instead of urea, as in mammals), since uric acid is the end product of protein metabolism in birds (Barrot et al. 1938; Deighton and Hutchinson, 1940; Barrot and Pringle, 1946). HP can be estimated from



CO<sub>2</sub> production alone, if the RQ is assumed. If the animal has been fasted sufficiently, then no serious error is involved in assuming an RQ of 0.71 (Sturkie, 1954). Table 1 below shows the relationship between RQ and calories per liters of O<sub>2</sub> consumed and CO<sub>2</sub> produced.

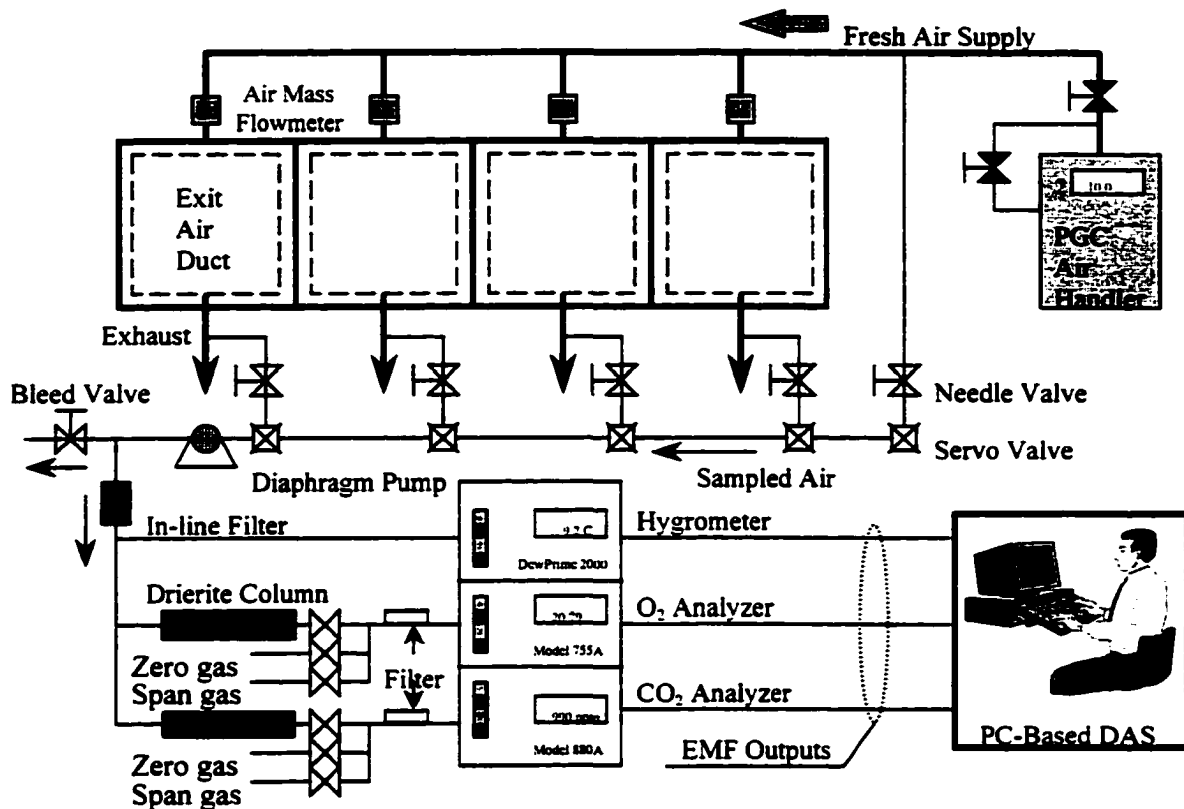
**Table 1. Relationship between RQ and calories per liter of O<sub>2</sub> consumed and CO<sub>2</sub> produced**

Calories per liter of	Respiratory Quotient (RQ)							
	0.70	0.71	0.75	0.80	0.85	0.90	0.95	1.00
O <sub>2</sub>	4.68	4.69	4.73	4.80	4.86	4.92	4.98	5.04
CO <sub>2</sub>	6.69	6.60	6.32	6.00	5.72	5.47	5.25	5.04

Courtesy: Sturkie, 1954

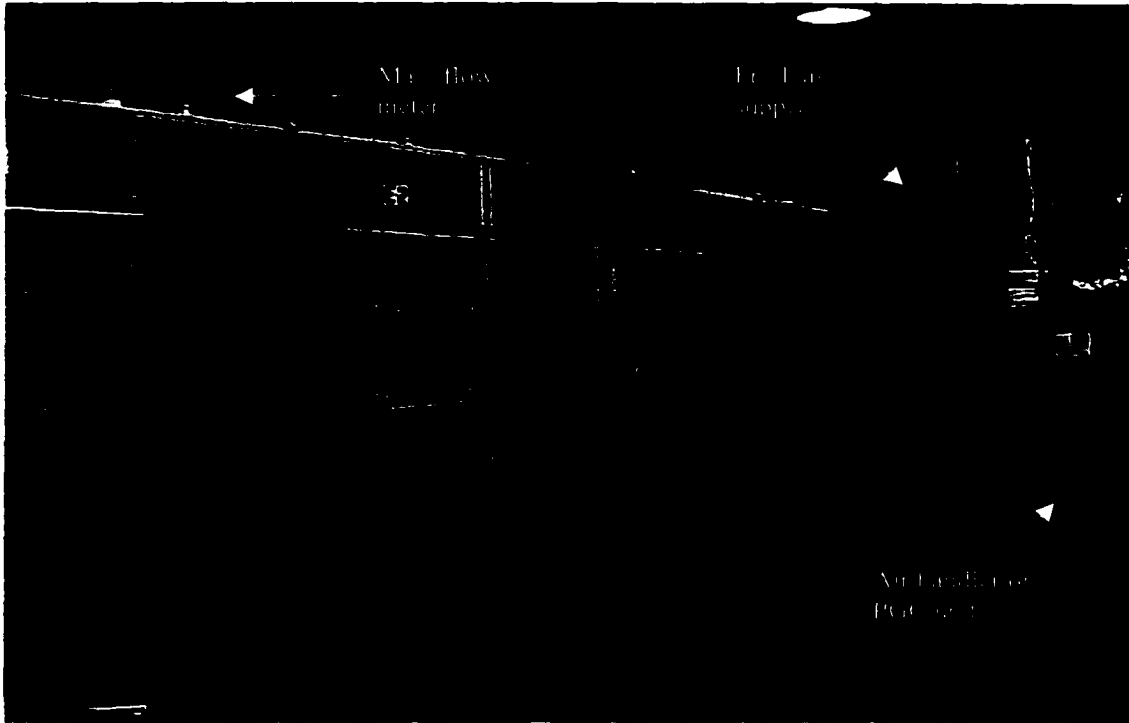
### **Iowa State University (ISU) Indirect Animal Calorimetry System**

Figure 1 shows the schematic of the ISU open-circuit, positive pressure indirect calorimetry system that was used in the HP and MP measurements. The system consists of the following major components: four individually controlled environmental chambers (1.52m W × 1.83m L × 2.40m H each); an air handler with a capacity of 850 m<sup>3</sup>/hr (Model Climate-Lab-AA, Parameter Generation & Control or PGC, Black Mountain, NC); a paramagnetic O<sub>2</sub> analyzer (Model 755A, Rosemount Analytical Inc., La Habra, CA); an infrared CO<sub>2</sub> analyzer (Model 880A, Rosemount Analytical Inc.); a dew point hygrometer (Model 2001, EG&G Moisture and Humidity Systems, Burlington, MA); a barometric

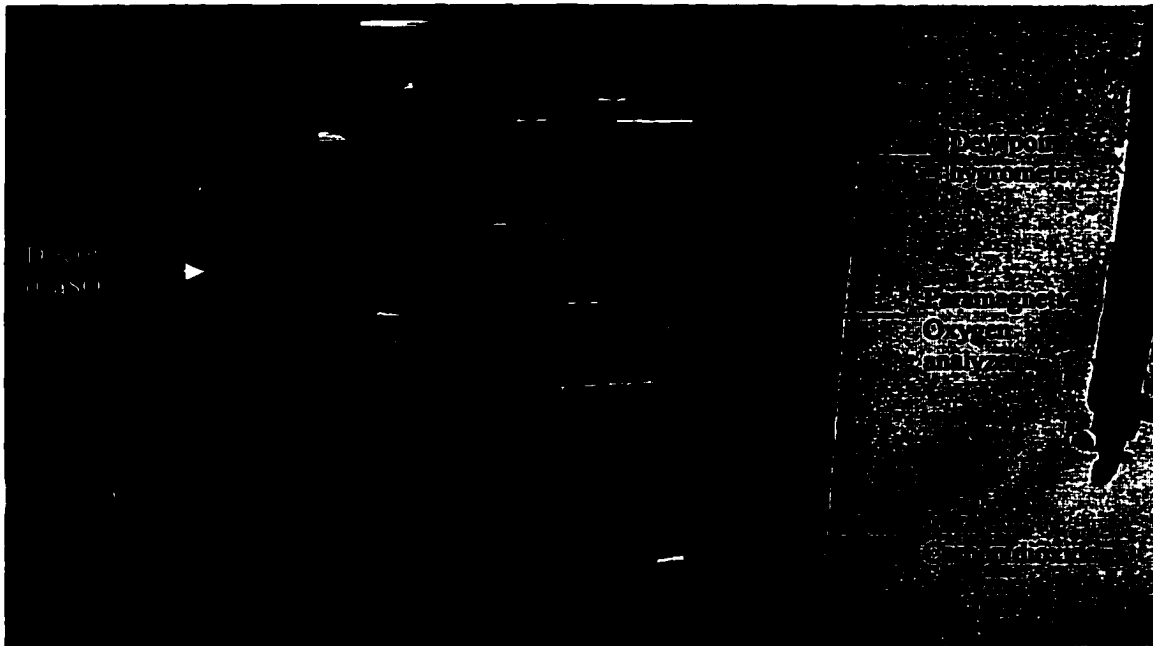


**Figure 1. Schematic representation of the ISU indirect animal calorimeter**

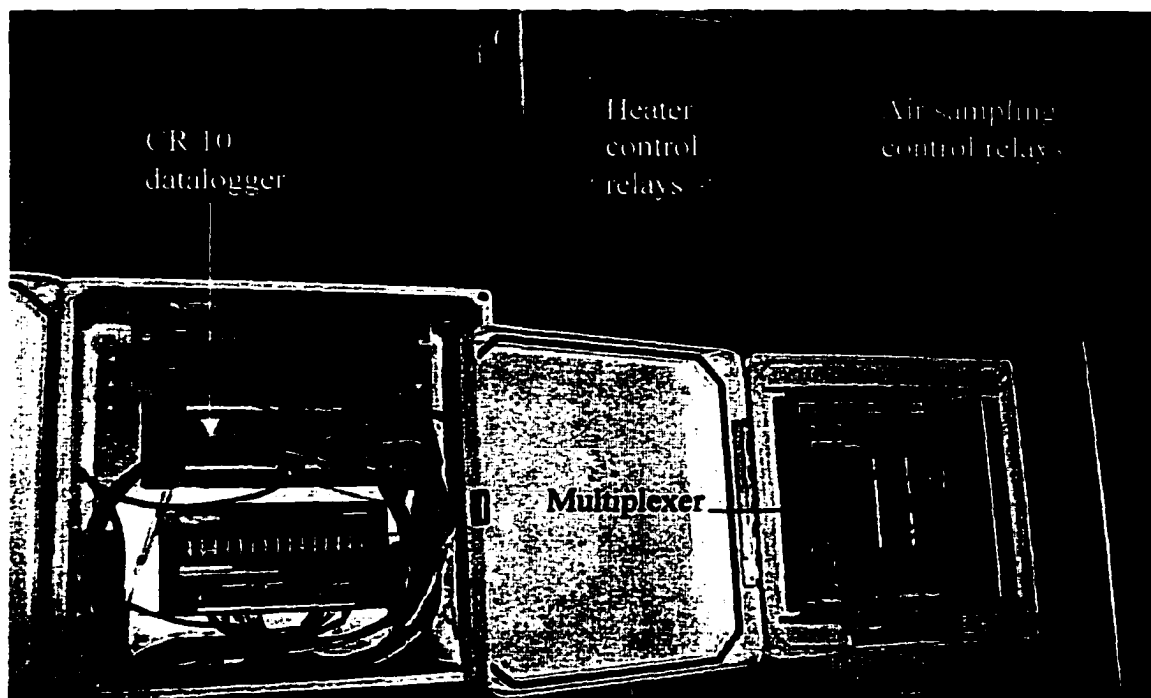
pressure sensor (Model CS105, Campbell Scientific Inc, Logan, UT); four thermoelectric air mass flowmeters, one per chamber (Model LS-4F, Teledyne Hastings-Raydist, Hampton, VA); an oil-free diaphragm air pump (Cat. No. H-07061-40, Cole Parmer Instrument Co., Niles, IL); and a PC-based environmental control and a data acquisition system (ECDAS). Figure 2 shows pictorial view of the calorimeters and some of the instruments. The fresh air supply was heated to the desired temperature of the chamber by two 1500 W electric heater/fan units (Model T621, Rival Manufacturing Co., Sedalia, MO) located in the plenum space of the air inlet and the porous ceiling of the chamber. An air distribution duct was located along the perimeter of the chamber near the bottom of the cage deck to enhance



**Figure 2a. The four indirect calorimeter chambers**



**Figure 2b. The gas analyzers and dew point hygrometer of the ISU indirect calorimeter system**



**Figure 2c. The CR10 datalogger, multiplexer and relays of the ISU indirect calorimeter system**

uniform mixing of the outgoing air. Electric heating cords (Cat. No. H-03122-24, Cole Parmer Instrument Co.) in conjunction with a variable power controller (Model 2604-00, Cole Parmer Instrument Co.) were used to prevent moisture condensation inside the air sample lines (6.4 mm diameter copper tubing). Air sampling was switched by the ECDAS-operated solenoid valves. Air flow rates of the sample lines (one fresh air and four exhaust air) were equalized with needle valves. Each chamber also had a temperature sensor connected to a phone dialer (Model Sensaphone 1104, Phonetics, Inc., Aston, PA) capable of calling up to four numbers if chamber temperature was outside the predetermined limits. Air sampling was performed at 7-min intervals, with the first 6-min used for system purging and stabilization and the last 1-min used for data collection. During the last minute, the ECDAS

took measurements of the concerned variables every two seconds and then stored the 30-point averages. The O<sub>2</sub> and CO<sub>2</sub> analyzers were calibrated with primary standard calibration gases (Matheson Gas Products, Inc., Chicago, IL) at least once daily throughout each experimental period.

### **Care and Operation of the Indirect Calorimeters**

#### **Before Operation**

The four thermoelectric air mass flow meters were calibrated by the factory to ensure uniform reading across the calorimeters. A CR10 program (Appendix 1) was developed to run the system. It performed: sequential and independent sampling and measurement readings of fresh air or air from individual calorimeters; continuous measurement of barometric pressure and mass flow rate of air entering the chambers; continuous measurement of fresh air and calorimeter air temperature, RH, dew point temperature; and turning the heaters on and off as needed to maintain the predetermined calorimeter temperature(s).

Voltage output from the analyzers (CO<sub>2</sub> and O<sub>2</sub>), dew point hygrometer and the mass flow meters were connected to the multiplexer (Figure 2c) that interfaced with the CR10 measurement and control module. Linear functional relationships (Appendix 2) existed between the voltage output and the physical unit of the measurement, which were incorporated into the CR10 program. This ensured that the digital output readings on the instruments matched the output readings on the computer display.

The gas analyzers were checked by combustion of pure ethanol for about three hours at the beginning of the series of experiments. The RQs were 0.65 for calorimeters 1, 2, and 3 and 0.64 for calorimeter 4 as compared to a theoretical value of 0.67.

### **During Operation**

During the course of experiments, the O<sub>2</sub> and CO<sub>2</sub> analyzers were calibrated twice daily using 99.999% nitrogen as zero gas. Primary-grade mixtures of 20.98% O<sub>2</sub> or 2019 ppm CO<sub>2</sub> with nitrogen balance were used as the span gases. Appendix 3 shows the behavior of the gas analyzers during the course of experiments.

The drierite or anhydrous CaSO<sub>4</sub> (W. A. Hammond Drierite Co. Ltd, Xenia, OH) was checked and replaced regularly to ensure that moisture did not enter the gas analyzers. The dew point hygrometer mirror was cleaned whenever the warning of contamination was displayed. The nozzles of the air handler or PGC unit were also cleaned regularly to remove mineral deposits that could clog them. All other system components were also constantly monitored. Between trials, regular system maintenance was performed and mass flow meters sent back to the factory for re-calibration whenever necessary.

### **Measurement of the Energetic Responses**

The following calculations were performed on the data collected.

Specific total heat production (THP, W/kg) of the birds was calculated using the short form of Brouwer's equation:

$$\text{THP} = 16.18\text{O}_2 + 5.02\text{CO}_2 \quad (\text{Brouwer, 1965}) \quad [4]$$

where O<sub>2</sub> is the oxygen consumption rate [mL·s<sup>-1</sup>·kg<sup>-1</sup>] at standard temperature (20°C), pressure (101.325 kPa) and dry basis or STPD (ASHRAE, 2000); CO<sub>2</sub> is the carbon dioxide production rate [mL·s<sup>-1</sup>·kg<sup>-1</sup>] at STPD; and O<sub>2</sub> and CO<sub>2</sub> were calculated as:

$$\text{O}_2 = V_i(X_i - \alpha \cdot X_o) \times 10^{-6} \quad [5]$$

$$\text{CO}_2 = V_i(\alpha \cdot Y_o - Y_i) \times 10^{-6} \quad [6]$$

where;  $V_i$  is the inlet air flow rate [ $\text{mL}\cdot\text{s}^{-1}\cdot\text{kg}^{-1}$ ] at STPD;  $X_i$ ,  $X_o$  is the oxygen concentration of the inlet and outlet air, respectively (ppm);  $Y_i$ ,  $Y_o$  is the carbon dioxide concentration of the inlet and outlet air, respectively (ppm); and  $\alpha$  is the correction factor for the outlet air flow rate, calculated as:

$$\alpha = \frac{V_o}{V_i} = \frac{1 - (X_i + Y_i) \cdot 10^{-6}}{1 - (X_o + Y_o) \cdot 10^{-6}} \quad (\text{McLean, 1972}) \quad [7]$$

The airflow rates measured were automatically converted to standard temperature ( $0^\circ\text{C}$ ) and pressure (101.325 kPa) or STP basis. The STP airflow rates ( $V_{STP}$ ) were then converted to dry basis ( $V_{STPD}$ ) with the following relationship:

$$V_{STPD} = \frac{V_{STP} (101.325 - P_w)}{101.325} \quad [8]$$

where  $P_w$  is the partial vapor pressure of the moist air (kPa), and calculated as:

$$P_w = 0.61078 \cdot e^{\left[ \frac{17.2693882 \cdot t_{dp}}{t_{dp} + 237.30} \right]} \quad (\text{Weiss, 1977}) \quad [9]$$

where  $t_{dp}$  is the dew point temperature in  $^\circ\text{C}$  of the inlet ( $P_{wi}$ ) or outlet ( $P_{wo}$ ) air and  $e$  is the base of the natural logarithms, 2.7182818. For calculation of  $V_{STPD(i)}$ ,  $t_{dp}$  of the inlet air was used.

Moisture production rate [MP,  $\text{g H}_2\text{O}\cdot\text{kg}^{-1}\cdot\text{h}^{-1}$ ] was calculated as:

$$\text{MP} = V_i \cdot \rho (\alpha \cdot W_o - W_i) \cdot \frac{3600}{1000} \quad [10]$$

where  $\rho$  represents density of air assumed to be  $1.293 \text{ g}\cdot\text{L}^{-1}$  at STPD; and  $W_i$ ,  $W_o$  are the humidity ratio of the inlet or outlet air, respectively, [ $\text{g H}_2\text{O} \cdot (\text{g dry air})^{-1}$ ] calculated as:

$$W = 0.62198 \left[ \frac{P_w}{P - P_w} \right] \quad (\text{Weiss, 1977}) \quad [11]$$

where  $P$  is the barometric pressure of ambient air (kPa); and  $P_w$  is as described by [9].

MP was used to determine latent heat production (LHP, W/kg),

$$LHP = \frac{MP \cdot h_{fg}}{3600} \quad [12]$$

where  $h_{fg}$  = latent heat of water vaporization. For trials where oil was used to suppress evaporation of moisture from feces,  $h_{fg}$  was  $2405 \text{ kJ}\cdot\text{kg}^{-1}$  based on  $T_b$  of the bird ( $41^\circ\text{C}$ ). On the other hand, for trials where oil was not used,  $h_{fg}$  was  $2427 \text{ kJ}\cdot\text{kg}^{-1}$  based on the mean temperature between  $T_b$  and  $21^\circ\text{C}$  ambient temperature.

Sensible heat production (SHP, W/kg) was calculated as the difference between THP and LHP:

$$SHP = THP - LHP \quad [13]$$

RQ was calculated as described by equation [2].

### **Measurement Error Analysis**

An error analysis of the measurement instruments indicated a maximum HP measurement error of  $\pm 0.63 \text{ W/calorimeter}$ . Because the HP magnitude of our study always exceeded  $65 \text{ W/calorimeter}$ , the measurement error was anticipated to have rather negligible effects on the results.

### **Scope of Research**

This study's major components involved: (1) performing an extensive literature review of HP and MP of poultry and their housing systems, (2) carrying out an intensive laboratory measurement of HP and MP of pullets and layers, and (3) carrying out an intensive laboratory measurement of HP and MP of layers during the molting stage, and (4)



applying the new HP and MP data in generation of building ventilation rates for selected poultry house and environmental conditions.

### **Study Objectives**

The objectives of this study were to:

1. perform a comprehensive review and comparative analysis of the HP and MP data in the literature, thereby identifying future research needs.
2. perform an intensive laboratory measurement of HP and MP of pullets and layers using large-scale indirect calorimetry, and to compare the results with those currently available in the literature. Furthermore, THP would be partitioned into LHP or MP and SHP of the *birds* (where oil was used to submerge the feces and suppress evaporation of fecal moisture) or the *room* (where oil was not used and MP and SHP included both moisture from the birds and feces).
3. perform an intensive laboratory measurement of HP and MP of layers during molting stage using large-scale indirect calorimetry. Oil was not used to submerge the feces, thus only *room* values were measured.
4. apply the new HP and MP data to generate building ventilation rates for selected poultry house and environmental conditions.

### **Dissertation Organization**

This dissertation comprises four papers, corresponding to the four research objectives.

The first paper entitled “Heat and Moisture Production of Poultry and Their Housing Systems: *Literature Review*” has been accepted for publication in the Transactions of the American Society of Heating, Refrigerating and Air Conditioning Engineers (ASHRAE). The second paper entitled “Heat and Moisture Production of Poultry and Their Housing

*Systems: Pullets and Layers*” has been submitted to the Transactions of the ASHRAE. The third paper entitled “Heat and Moisture Production of Poultry and Their Housing Systems: *Molting Layers*” will be submitted to the Transactions of the ASHRAE. The fourth paper entitled “Heat and Moisture Production of Poultry and Their Housing Systems: *An application in building ventilation rate design*” will be submitted to the Journal of Applied Engineering in Agriculture. All the papers have an abstract, introduction, materials and methods, results and discussion, conclusions, and references. These papers are followed by a general conclusion for the entire research.

### References

- ASHRAE Handbook. Fundamentals. 2001. American Society of Heating, Refrigerating and Air Conditioning Engineers, Inc., Atlanta, GA.
- ASHRAE HVAC Systems and Equipment Handbook. 2000. Fans. American Society of Heating, Refrigerating and Air Conditioning Engineers, Inc., Atlanta, GA.
- Barott, H. G., Fritz J. C., Pringle E. M., and Titus H. W. 1938. Heat production and gaseous metabolism of young male chickens. *Journal of Nutrition* 15(1):145-167.
- Barott, H. G., and Pringle E. M. 1946. Energy and gaseous metabolism of the chicken from hatch to maturity as affected by temperature. *Journal of Nutrition* 31(1):35-50.
- Boshouwers, F. M. G. and Nicaise E. 1985. Automatic gravimetric calorimeter with simultaneous recording of physical activity for poultry. *British Poultry Science* 26(4):531-541.
- Brody, S. 1945. Bioenergetics and Growth. Reinhold Publishing Company, New York.

- Brouwer, E. 1965. Report of sub-committee on constant and factors. *In: Energy metabolism. Proc. Of the third Symposium, 441-443, Troon, Scotland, European Association for Animal Production.* ed. K. L. Blaxter. London, England: Academic Press.
- Chepete, H. J. and Xin. H. 2002a. Heat and moisture production of poultry and their housing systems: *Literature review. Transactions of the ASHRAE (In press).*
- Chepete, H. J. and Xin. H. 2002b. Heat and moisture production of poultry and their housing systems: *Pullets and Layers. Transactions of the ASHRAE (In review).*
- Chwalibog, A. and Eggun B. O. 1989. Effect of temperature on performance, heat production, evaporative heat loss and body composition in chickens. *Archiv für Geflügelkunde.* 53 (4):179-184.
- Dale, H. E. 1984. Energy metabolism. *In Duke's physiology of domestic animals, 10<sup>th</sup> edition.* Cornell University Press, Ithaca, NY.
- Davidson, J. 1964. The efficiency of conversion of dietary metabolizable energy to tissue energy in young chickens as measured by body analyses. European Association of Animal Production; 3<sup>rd</sup> Symposium on Energy Metabolism, Troon.
- Deaton, J. W. 1983. Alleviation of heat stress for avian egg production – a review. *World Poultry Science Journal* 39(2):210-217.
- Deighton, T. and Hutchinson J. C. D. 1940. Studies on the Metabolism of Fowls. II. The Effect of Activity on Metabolism. *Journal of Agriculture Science.* 30(1):141-157.
- Dubensky, H. J., Puri V. M, Manbeck H. B., and Roush W. B. 1986. Heat and moisture production of layers in constant and dynamic environments. ASAE paper No. 86-4068. St. Joseph, MI.

- El Boushy, A. R. and van Marle A. L. 1978. The effect of climate on poultry physiology in tropics and their improvement. *World Poultry Science Journal* 34(3):155-171.
- Gates, R. S., Overhults D. G., and Zhang S. H. 1996. Minimum ventilation for modern broiler facilities. *Transactions of the ASAE* 39(3):1135-1144.
- Hartung, J. 1994. Environment and animal health. In: Livestock housing (Wathes C. M.; Charles R. D.; eds) pp. 25-48. CAB International.
- Heninger, R. W., Newcomer W. S., and Thayer R. H. 1960. The effect of elevated ambient temperatures on the thyroxine secretion rate in chickens. *Poultry Science* 39(6):1332-1337.
- Huston, T. M., Edwards H. M, Jr., and Williams J. J. 1962. The effects of high environmental temperature on thyroid secretion rate of the domestic fowl. *Poultry Science* 41(2):640-645.
- Koskemies, J. 1950. The life of the swift, *Micropus apus* (L) in relation to the weather. *Annales Academiae Scientiarum Fennicae, Series A, IV, Biologica* 15:1-151.
- Lasiewski, R. C. 1963. Oxygen consumption of torpid, resting, active and flying hummingbirds. *Physiological Zoology* 36(2):122-140.
- Longhouse, A.D., Ota, H. and Ashby, W. 1960. Heat and moisture design data for poultry housing. *Agricultural Engineering* 41(9): 567-576.
- McLean, A. J. 1972. On the calculation of heat production from open-circuit calorimetric measurements. *British Journal of Nutrition* 27(3):597-600.
- McLeod, M. G. and Jewitt T. R. 1984. Circadian variation in the heat production rate of the domestic fowl, *gallus domesticus*: effects of limiting feeding to a single daily meal. *Compendium of Biochemistry and Physiology* Vol. 78A (4):687-690.

- Meltzer, A. 1987. Acclimation to ambient temperature and its nutritional consequences. *World Poultry Science Journal* 43(1):33-44.
- Meltzer, A., Goodman G. and Fistul J. 1982. Thermoneutral zone and resting metabolic rate of growing White Leghorn type chicks (*Gallus domesticus*). *British Poultry Science* 23(5):383-391.
- Mitchell, H. H. 1962. Comparative nutrition of man and domestic animals, Vol. 1. Academic Press, New York.
- North, M. O. 1972. Commercial chicken production manual. The Avi Publishing.
- Ota, H. and McNally E. H. 1961. Poultry respiration calorimetric studies of laying hens...Single Comb White Leghorns, Rhode Island Reds, and New Hampshire × Cornish Cross. Agricultural Research Service, 42. U.S. Department of Agriculture.
- Pearson, O. P. 1950. The metabolism of hummingbirds. *The Condor* 52(4):145-152.
- Reece, F. N. and Deaton J. W. 1971. Use of evaporative cooling for broiler chicken production in areas of high relative humidity. *Poultry Science* 50(1):100-104.
- Reece, F. N. and Lott B. D. 1982a. Heat and moisture production of broiler chickens during brooding. *Poultry Science* 61(3):661-666.
- Reece, F. N. and Lott B. D. 1982b. The effect of environmental temperature on sensible and latent heat production of broiler chickens. *Poultry Science* 61(8):1590-1593.
- Renwick, G. M., Washburn K. W. and Lanza G. M. 1985. Genetic variability in growth response of chicks to cold brooding temperature. *Poultry Science* 64(5):785-788.
- Riskowski, G. L., deShazer J. A. and Mather F. B. 1977. Heat losses of White Leghorn laying hens as affected by intermittent lighting schedules. *Transactions of the ASAE*, 20(4):727-731.

- Scott, T. R. and Washburn K. W. 1985. Evaluation of growth. Hormonal and hematological responses of neonatal chickens to reduce temperature brooding. *Poultry Science* 64(5):777-784.
- Sturkie, P. D. 1954. Avian Physiology. Comstock Publishing Associates, Ithaca, New York.
- Vo, K. V., Boone M. A., Hughes B. L. and Knechtges J. F. 1980. Effects of ambient temperature on sexual maturity in chickens. *Poultry Science* 59(11):2532-2537.
- Weiss, A. 1977. Algorithms for the calculation of moist air properties on a hand calculator. *Transactions of the ASAE* 20(4):1133-1136.
- Whittow, G. C. 1965. Energy metabolism. In Avian Physiology. 2<sup>nd</sup> edition. (P. D. Sturkie, ed.). Comstock Publishing Associates. Ithaca, N.Y.
- Whittow, G. C., Sturkie P. D., and Stein G. Jr. 1964. Cardiovascular changes associated with thermal polypnea in the chicken. *American Journal of Physiology* 207(6):1349-1353.
- Xin, H. Berry I. L., Tabler G. T., and Costello T. A. 2001. Heat and moisture production of broiler chickens in commercial housing. *Transactions of the ASAE* 44(6):1853-1859.
- Xin, H., Chepete H. J., Shao J., and Sell J. L. 1998. Heat and moisture production and minimum ventilation requirements of Tom turkeys during brooding-growing period. *Transactions of the ASAE* 41(5):1489-1498.
- Xin, H., Sell J. L., and Ahn D. U. 1996. Effects of light and darkness on heat and moisture production of broilers. *Transactions of the ASAE* 39(6):2255-2258.
- Yunianto, V. D., Hayashi K., Kanade S., Ohtsuka A., and Tomita Y. 1997. Effect of environmental temperature on muscle protein turnover and heat production in tube-fed broiler chickens. *British Journal of Nutrition* 77(6):897-909.

Zulovich, J. M., Manbeck H. B. and Roush W. B. 1987. Whole-house heat and moisture production of young floor brooded layer pullets. *Transactions of the ASAE* 30(2):455-458.

**CHAPTER 2.****HEAT AND MOISTURE PRODUCTION OF POULTRY AND THEIR  
HOUSING SYSTEMS: *LITERATURE REVIEW***

A paper accepted for publication by the Transactions of the American Society of Heating,  
Refrigerating and Air-conditioning Engineers (ASHRAE)

H. J. Chepete and H. Xin

**ABSTRACT**

An extensive literature review and comparative analysis of heat and moisture production of various poultry types and their housing systems are presented. From each published article, the data extracted included breed, body mass ( $M$ ), and age of the birds; temperature, RH, and photoperiod maintained during the study; measured values of latent heat, sensible heat and total heat production rate (LHP, SHP, and THP); the type of study used (direct vs. indirect calorimetric studies); feeding regimen (ad-libitum vs restricted); number of birds used; type of waterers used; and duration of the study. LHP, SHP and THP were explicitly indicated in some articles, while in others regression equations were published. THP (W/kg) was observed to have increased over the years in all poultry types. Specifically, THP increased by about 21 to 44% over a 14-year period (1968 to 1982) for broilers weighing 0.1 to 1.6 kg and by 15 to 22% for broilers at 1.4 to 1.6 kg over a 32- year period (1968 to 2000). Only one study was found for pullets and data were thus insufficient to draw any conclusions about the trend of THP. Data for pullets & layers between 7 and 33 wk old at thermoneutral environment are not available. Tom turkeys weighing 0.4 to 1.0 kg experienced an increase



in THP of 36 to 63% over a 24-year period (1974 to 1998). Data for heavier turkeys were insufficient to make reasonable comparisons in the trend of THP. The metabolic rate equations derived from the literature data were in good agreement with the standard metabolic rate  $HP (W/bird) = a M^b$ , where  $b = 0.66$  to  $0.75$ . Specifically, it was  $8.55 M^{0.74}$  (1968) and  $10.62 M^{0.75}$  (1982 to 2000) for broilers;  $6.47 M^{0.77}$  for pullets and layers (1953 to 1990);  $7.54 M^{0.53}$  (1974 to 1977) and  $9.86 M^{0.77}$  (1992 to 1998) for turkeys. Results of the review thus affirm the need to collect new HP and MP data that represent modern production conditions with respect to genetics, nutrition, housing types and management schemes.

**KEYWORDS:** Energetics, Ventilation, Calorimetry, Environmental Control.

## **INTRODUCTION**

Reliable data on heat and moisture production (HP and MP) of housed animals are crucial for building ventilation design specifications (Hartung 1994; Reece and Lott 1982a; Reece and Deaton 1971). The quantity of HP and MP from poultry varies with breed, age, body mass, degree of activity, nutritional plane, and environmental temperature (Meltzer 1987; Deighton and Hutchinson 1940).

Improved bird nutrition and especially bird genetics have contributed to dramatic increases in poultry growth rates. Havenstein et al. (1991) claimed that today's broiler chickens grew about 3.5 times faster than those in 1957. Reece and Lott (1982c) reported that the growth rate of broilers approximately doubled that reported by Longhouse et al. (1960) and was about 40% greater than that reported by Deaton et al. (1969) and Reece et al. (1969). Flood et al. (1992) reported growth rates of about 25% greater than those reported by Simmons et al. (1987) and Reece and Lott (1982c).

HP and MP are measured by either direct calorimetry (DC) or indirect calorimetry (IC). DC directly measures heat loss from an enclosure housing the animals (ventilation and conductive heat losses) while IC relates respiratory gaseous exchange to energy or heat production.

HP and MP data in the literature date as far back as 20 to 50 years. The specific total heat production (THP, W/kg) is often partitioned into specific sensible heat and latent heat production (SHP and LHP). Several authors (ASHRAE 2001; Xin et al. 1998; Gates et al. 1996; Reece and Lott 1982a, b) have pointed out an urgent need to update the HP and MP characteristics of modern poultry production facilities for the design and operation of environmental control systems. This urgent need arises from the significant changes over the years in animal genetics, nutrition, housing equipment and management practices. The objective of this paper was to perform a comprehensive review and comparative analysis of the HP and MP data in the literature, thereby identifying areas of future research needs.

## **METHOD OF DATA COLLECTION AND PRESENTATION**

From the literature articles, the necessary data were extracted and organized into summary tables. The data were presented to include or represent the following conditions: a) *type of study* – DC or IC with or without inclusion of moisture evaporation from feces conducted at lab-scale or whole-house; b) *drinker type* – open trough or nipple; c) *lighting condition* – light or dark; d) *nutritional level* – ad-lib or limited feeding; e) *genetic strain* where possible; f) *bird age or body mass*; g) *ambient temperature*; h) *relative humidity (RH)* where possible; i) number of birds involved in the measurement; and j) duration of the measurement.

All the numerical data (body mass or M, HP, and MP) were converted to SI units, where necessary. In some papers, the HP data were explicitly presented while in others regression equations were used to calculate HP values. Some original authors were contacted for information that could not be obtained from their published articles. To examine and illustrate the magnitude of change in THP over the time period, THP associated with the thermoneutral (TN) conditions (15 to 30 °C, depending on bird age) from various sources were plotted and non-linear regression models developed as functions of M using Sigma Plot 2001 software (SPSS, Inc). The coefficients in each model were significant ( $P < 0.05$ ). THP data from studies where birds were under non-TN conditions, fasting or limited feeding, and data derived from other studies were excluded from the plots or regression models. However, they are presented in the tables, along with those under TN and *ad-libitum* fed conditions.

## **RESULTS AND DISCUSSION**

### **HP & MP Data for Broilers**

The HP and MP data for broilers over the years 1958 to 2000 are presented in Table 1. THP data for the period of 1968 to 2000 at TN environment are plotted in Figure 1. Equations used in the literature are presented in Appendix 1.

The best-fit regressions were separately performed to the THP scatter plot for the 1982 to 2000 and 1968 data. The results are as follows with the M range specified and the total number of data points (N) shown in parentheses.

For 1968 (Longhouse et al., 1968) at  $M = 0.05$  to  $2.00$  kg ( $N = 13$ ),

$$\text{THP (W/kg)} = 8.55(\pm 0.23) M^{-0.26(\pm 0.01)} \text{ or } \text{THP (W/bird)} = 8.55 M^{0.74} (R^2 = 0.97) \quad (1)$$

For 1982 to 2000 (Pederson and Thomsen, 2000; Xin et al., 1996; Feddes et al., 1984; Reece and Lott, 1982a,b; and Longhouse et al., 1968) at  $M = 0.09$  to  $3.00$  kg ( $N = 30$ ),

$$\text{THP (W/kg)} = 10.62 (\pm 0.29) M^{-0.25(\pm 0.02)} \text{ or } \text{THP (W/bird)} = 10.62 M^{0.75} \quad (R^2 = 0.91) \quad (2)$$

These equations compared very well to the general relationship that animals expend energy in proportion to their metabolic mass,  $\text{kg}^{0.75}$ . For broilers, the following equations had been reported:

$$\text{THP (W/bird)} = 9.6 M^{0.75} \quad (\text{Jorgensen et al., 1996}) \quad (3)$$

$$\text{THP (W/bird)} = 10.0 M^{0.75} \quad (\text{CIGR Handbook, 1999}) \quad (4)$$

THP seems to be generally higher in the recent studies than in the older studies at a given  $M$ . For example, at  $0.1$ ,  $0.4$ ,  $0.6$ ,  $1.4$ , and  $1.6$  kg, THP was about 25, 21, 44, 27 and 35% higher, respectively, in 1982 (Reece and Lott) than in 1968 (Longhouse et al.) (14 years). It was also 40% higher in 1984 (Feddes et al.) than in 1968 (Longhouse et al.) at  $1.4$  kg (16 years). Between 1968 (Longhouse et al.) and 2000 (Pederson and Thomsen) (32 years), THP for the  $1.4$  and  $1.6$  kg increased by 15 and 22%, respectively.

Simmons et al. (1997) studied the effects of five different air velocities ( $1.0$ ,  $1.5$ ,  $2.0$ ,  $2.5$ , and  $3.1$  m/s) on HP of 5- to 6-wk-old broilers under three warm temperature regimens of  $29.0$ ,  $32.0$ , and  $35.0^\circ\text{C}$  using a wind tunnel (Table 1). They found that SHP increased and LHP decreased with increasing air velocity. Furthermore, at the fixed air velocity of  $2.0$  m/s, SHP decreased and LHP increased as air temperature was increased while THP remained unchanged.

## HP & MP Data for Pullets and Layers

The HP and MP data for layers over the years 1953 to 1990 are presented in Table 2. THP data for the same period at TN environment are plotted in Figure 2. Equations used in the literature are presented in Appendix 2.

A best-fit regression was performed to the THP scatter plot with 28 data points from the following sources: Li et al. (1990); Zulovich et al. (1987); Dubensky et al. (1986); Puri et al. (1985); Feddes et al. (1985); Riskowski et al. (1978); Ota and McNally (1961); and Ota and Garver (1953) at  $M = 0.06$  to 2.80 kg. The equation was:

$$\text{THP (W/kg)} = 6.47(\pm 0.35) M^{-0.23(\pm 0.04)} \text{ or } \text{THP (W/bird)} = 6.47 M^{0.77} \quad (R^2 = 0.56) \quad (5)$$

This compared very well to the general relationship that animals expend energy in proportion to the metabolic mass,  $\text{kg}^{0.75}$ . For layers kept in cages, it is specifically:

$$\text{THP (W/bird)} = 6.28 M^{0.76} + 25Y \quad (\text{CIGR Handbook, 1999}) \quad (6)$$

For layers reared on the floor:

$$\text{THP (W/bird)} = 6.80 M^{0.76} + 25Y \quad (\text{CIGR Handbook, 1999}) \quad (7)$$

where

$Y = \text{egg production (kg/d)}$ .

For 1.7 kg layers, THP was 5.7 W/kg in 1978 (Riskowski et al.), 7.9 W/kg in 1985 (Feddes et al.), 10.7 W/kg in 1986 (Dubensky et al.), and 5.9 W/kg in 1990 (Li et al.). The difference in THP was as high as 88% during this period, although the data were quite limited and some came from non-refereed sources such as Dubensky et al. (1986), Puri et al., (1985), and Ota and McNally (1961). The ASHRAE Handbook (2001) and ASAE Standards

(2000) use data by Ota & McNally (1961) as the basis in design of ventilation systems for laying hens.

The only data found for pullets (up to 7 wks or 0.54 kg) were reported by Zulovich et al. (1987). It is also the only pullet data referenced in the ASHRAE Handbook (2001). Data between 7- and 33-wk (0.54 to 1.50 kg) old birds were not found (fig. 2). Research is thus needed to generate more and new data for pullets (up to 20 wks of age).

### **HP & MP Data for Turkeys**

The HP and MP data for turkeys over the years 1974 to 1998 are presented in Table 3. THP data over the years between 1992 to 1998 and 1974 to 1977 at TN environment (15 to 30 °C, depending on bird age), are plotted in Figure 3. Equations used in the literature are presented in Appendix 3.

The best-fit regressions were performed to the THP scatter plot. The results were as follows:

For 1974 to 1977 (Shanklin et al., 1977; Buffington et al., 1974; and DeShazer et al., 1974) for  $M = 0.42$  to  $17.40$  kg ( $N = 18$ ),

$$\text{THP (W/kg)} = 7.54(\pm 0.23) M^{-0.47(\pm 0.03)} \text{ or THP (W/bird)} = 7.54 M^{0.53} \quad (R^2 = 0.96) \quad (8)$$

For 1992 to 1998 (Xin et al., 1998; and Feddes and McDermott, 1992) at  $M = 0.20$  to  $11.10$  kg ( $N = 21$ ),

$$\text{THP (W/kg)} = 9.86(\pm 0.38) M^{-0.23(\pm 0.03)} \text{ or THP (W/bird)} = 9.86 M^{0.77} \quad (R^2 = 0.75) \quad (9)$$

Once again, the 1992 to 1998 data compared very well to the general relationship that animals expend energy in proportion to the metabolic body mass,  $\text{kg}^{0.75}$ . However, the

regression of the 1974 to 1977 data had a lower power term (0.53) which could have resulted from the wide gap between  $M = 1$  to 9 kg (fig. 3). The relationship between THP (W/bird) and  $M$  for turkeys was not found in the literature.

For  $M$  of 0.4, 0.7 and 1.0 kg, THP values for toms increased by 36, 63 and 47%, respectively, between 1974 (DeShazer et al.) and 1998 (Xin et al.) (24 years). For  $M = 9.1$  kg, THP was about 1.6 and 6.8 W/kg for the 1977 (Shanklin et al.) hen and 1992 (McDermott) tom, respectively. Data were not sufficient to make comparisons for heavy toms. More research to generate such data is thus warranted. The ASHRAE Handbook (2001) and the ASAE Standards (2000) presented data by Buffington et al. (1974) and DeShazer et al. (1974) that are widely used in the design of ventilation systems for turkeys. Data for heavier turkeys are not presented in the ASHRAE Handbook, and the ASAE Standards (2000) only presented data by Shanklin et al. (1977).

For turkeys of 1.1 kg, THP was about 17% higher in 1998 (Xin et al.) than in 1974 (Buffington). Interestingly, for 1.7 kg, THP in 1998 and 1974 was similar. The 1998 study involved only toms while the 1974 study involved both hens and toms. It took 28d and 39d for a turkey to reach 1.1 kg in 1998 and 1974, respectively. For 1.7 kg, the growth period was 35d and 50d for 1998 and 1974, respectively. The faster growth of modern turkeys is presumably attributed to improved genetics, nutrition and management practices.

## **CONCLUSIONS**

This review of literature clearly demonstrates that THP of poultry increased over the years presumably due to advancements in genetics, nutrition, housing and management practices, as suggested by many authors in the recent literature. Accompanying this increase

in THP would be changes in the magnitudes of SHP and LHP or MP. These changes may have significant effects on the physical design of modern poultry structures and environmental control systems, particularly air quality control which could directly affect the animal and human health and production efficiency. The review further revealed the existence of data gaps for certain body mass of certain species. Hence there is a strong need to conduct an intensive, systematic measurement to update and bridge the gaps in HP and MP for modern poultry. Specifically, future research should consider the effects of housing types, manure management schemes, bird genetics, nutrition, and photoperiod on HP and MP. Moreover, future studies should partition THP into SHP and LHP for both the animals and the rooms. This way, contribution of moisture evaporation from the surroundings (e.g., manure and drinkers) to room heat and moisture loads under different environmental conditions could be quantified.

## **ACKNOWLEDGEMENT**

Funding for this study was provided by the American Society of Heating, Refrigerating and Air-conditioning Engineers (ASHRAE), and is acknowledged with gratitude.

## **REFERENCES**

- ASAE Standards, 47<sup>th</sup> Ed. 2000. Design of ventilation for poultry and livestock shelters, EP 270.5, 607. St. Joseph, MI: ASAE.
- ASHRAE Handbook. Fundamentals. 2001. American Society of Heating, Refrigerating and Air Conditioning Engineers, Inc., Atlanta, GA.
- Buffington, D. E., Jordan K. A., Junnila W. A. and Boyd L. L. 1974. Heat production of active, growing turkeys. *Transactions of the ASAE* 17(3):542-545.



- CIGR Handbook of Agricultural Engineering. 1999. Animal Production & Aquacultural Engineering, Vol. 2. ASAE.
- Deaton, J. W., Reece F. N., and Bouchillon C. W. 1969. Heat and moisture production of broilers, 2. Winter conditions. *Poultry Science* 48(5):1579-1582.
- Deighton, T. and Hutchinson J. C. D. 1940. Studies on the Metabolism of Fowls. II. The Effect of Activity on Metabolism. *Journal of Agriculture Science*. 30(1):141-157.
- DeShazer, J. A., Olson L. L. and Mather F. B. 1974. Heat losses of large white turkeys – 6 to 36 days of age. *Poultry Science* 53(6):2047-2054.
- Dubensky, H. J., Puri V. M, Manbeck H. B., and Roush W. B. 1986. Heat and moisture production of layers in constant and dynamic environments. ASAE paper No. 86-4068. St. Joseph, MI.
- Feddes, J. J. R. and McDermott K. 1992. Turkey heat production measured directly and indirectly under commercial-scale conditions. *Canadian Agricultural Engineering* 34(3):259-265.
- Feddes, J. J. R., Leonard J. J., and McQuitty J. B. 1984. Broiler heat and moisture production under commercial conditions. *Canadian Agricultural Engineering* 26(1):57-64.
- Feddes, J. J. R., McQuitty J. B., and Clark P. C. 1985. Laying hen and moisture production under commercial conditions. *Canadian Agricultural Engineering* 27(1):21-29.
- Flood, C. A., Trumbull R. D., and Brewer R. N. 1992. Broiler growth data: 1986-1991. *Transactions of the ASAE* 35(2):703-709.
- Gates, R. S., Overhults D. G., and Zhang S. H. 1996. Minimum ventilation for modern broiler facilities. *Transactions of the ASAE* 39(3):1135-1144.

- Han, T. and Xin H. 2000. Effects of intermittent lighting on breeder chicks provided with “in-transit” nutrients. *Transactions of the ASAE* 43(6):1767-1770.
- Hartung, J. 1994. Environment and animal health. *In: Livestock housing* (Wathes C. M.; Charles R. D.; eds) pp. 25-48. CAB International.
- Havenstein, G. B., Scheidelar S. E., Ferket P. R., Qureshi M. A., Christensen V., and Donaldson W. E. 1991. A comparison of the 1957 Athens/Canadian random bred control strain with the 1991 Arbor Acres broiler when fed diets typical of those fed in 1957 and 1991. *In Proc. North Carolina State Poultry Supervisors’ Short Course*, 1 April 1992.
- Jorgensen, H., Zhao X. Q., Knudsen K. E. B., and Eggum B. O. 1996. The influence of dietary fibre source and level on the development of the gastrointestinal tract, digestibility and energy metabolism in broiler chickens. *British Journal of Nutrition* 75(3):379-395.
- Li, Yuzhi, Ito T. and Yamamoto S. 1990. Diurnal variation in heat production related to some physical activities in laying hens. *British Poultry Science* 32(4):821-827.
- Longhouse, A. D., Ota H., Emerson R. E., and Heishman J. O. 1968. Heat and moisture design data for broiler houses. *Transactions of the ASAE* 2(5):694-700.
- Longhouse, A.D., Ota, H. and Ashby, W. 1960. Heat and moisture design data for poultry housing. *Agricultural Engineering* 41(9): 567-576.
- Meltzer, A. 1987. Acclimation to ambient temperature and its nutritional consequences. *World Poultry Science Journal* 43(1):33-44.
- O’Connor, J. M., McQuitty J. B., and Clark P. C. 1987. Heat and moisture loads in three commercial broiler breeder barns. *Canadian Agricultural Engineering* 30(2): 267-271.

- O'Neill, S. J. B. and Jackson N. 1974. The heat production of hens and cockerels maintained for an extended period of time at a constant environmental temperature of 23°C. *Journal of Agricultural Science, Cambridge* 82(3): 549-552.
- Ota, H. and Garver H. L. 1953. Heat and moisture production of laying hens. *Agricultural Engineering* 34(3):163-167.
- Ota, H. and Garver H. L. 1958. Heat and moisture data from growing birds on litter and single comb caged White Leghorn layers. ASAE Paper 58-203, ASAE, St. Joseph, Mich. 49085.
- Ota, H. and McNally E. H. 1961. Poultry respiration calorimetric studies of laying hens...Single Comb White Leghorns, Rhode Island Reds, and New Hampshire × Cornish Cross. Agricultural Research Service, 42. U.S. Department of Agriculture.
- Pedersen, S. and Thomsen M. G. 2000. Heat and moisture production of broilers kept on straw bedding. *Journal of Agricultural Engineering Research* 75(2): 177-187.
- Puri V. M., Dubensky H. J., and Manbeck H. B. 1985. Prediction of heat production of layers in dynamic environments. ASAE paper No. 85-4022. St. Joseph, MI.
- Reece F. N., Deaton J. W., and Bouchillon C. W. 1969. Heat and moisture production of broilers, 1. Summer conditions. *Poultry Science* 48(4):1297-1303.
- Reece, F. N. and Deaton J. W. 1971. Use of evaporative cooling for broiler chicken production in areas of high relative humidity. *Poultry Science* 50(1):100-104.
- Reece, F. N. and Lott B. D. 1982a. Heat and moisture production of broiler chickens during brooding. *Poultry Science* 61(3):661-666.
- Reece, F. N. and Lott B. D. 1982b. The effect of environmental temperature on sensible and latent heat production of broiler chickens. *Poultry Science* 61(8):1590-1593.

- Reece, F. N. and Lott B. D. 1982c. Typical broiler chicken growth rates. *Poultry Science* 61(6):1013-1014.
- Riskowski, G. L., DeShazer J. A., and Mather F. B. 1978. Heat losses of White Leghorn laying hens as affected by intermittent lighting schedules. *Transactions of the ASAE* 20(4):727-731.
- Shanklin, M. D., Malhotra R. K., Hahn G. L., and Biellier H. V. 1977. Prediction equations for heat losses of mature broad breasted bronze turkeys. *Transactions of the ASAE* 20(1): 148-149, 154.
- Simmons, J. D., Hughes B. L., and Allen W. H. 1987. Research note: Growth and waste production of broilers during brooding. *Poultry Science* 66(4):762-764.
- Simmons, J. D., Lott B. D., and May J. D. 1997. Heat loss from broiler chickens subjected to various air speeds and ambient temperatures. *Applied Engineering in Agriculture* 13(5):665-669.
- Xin, H., Chepete H. J., Shao J., and Sell J. L. 1998. Heat and moisture production and minimum ventilation requirements of Tom turkeys during brooding-growing period. *Transactions of the ASAE* 41(5):1489-1498.
- Xin, H., DeShazer J. A., and Beck M. M. 1992. Responses of pre-fasted growing turkeys to acute heat exposure. *Transactions of the ASAE* 35(1):315-318.
- Xin, H., and Harmon J. D. 1996. Responses of group-housed neonatal chicks to posthatch holding environment. *Transactions of the ASAE* 39(6):2249-2254.
- Xin, H., Sell J. L., and Ahn D. U. 1996. Effects of light and darkness on heat and moisture production of broilers. *Transactions of the ASAE* 39(6):2255-2258.

Zulovich, J. M., Manbeck H. B. and Roush W. B. 1987. Whole-house heat and moisture production of young floor brooded layer pullets. *Transactions of the ASAE* 30(2): 455-458.

**TABLE 1**  
**Summary of literature data on heat and moisture production of ad-lib fed broilers.**  
**Values in *italics* were calculated from the other two known HP variables (i.e., THP =**  
**LHP + SHP)**

M (kg)	Age (d or wk)	Ta (°C)	RH (%)	LHP (W/kg)	SHP (W/kg)	THP (W/kg)	No. birds	Duration	Light	Type	Waterer	[Ref.,Yr]
1.2	28d	22.0	60	4.7	4.6	9.3	6000	28-35d	cont.	B/D	nipple	[1,2000]*
1.4	30d	22.0	65	4.6	4.5	9.1	6000	cont.				
1.4	32d	22.4	65	4.5	4.6	9.0	7200					
1.6	35d	22.4	65	4.3	4.4	8.8	7200					
1.7	35d	29.0	52				500	2.5h/d for 3d	no light	A/D	no water	[2, 1997]*
		(v, m/s = 1.0	1.0	2.9	1.2	4.0						
		1.5	1.5	2.9	1.4	4.2						
		2.0	2.0	2.7	1.6	4.3						
		2.5	2.5	2.5	1.8	4.3						
		3.1)	3.1)	2.1	2.1	4.2						
		32.0	45									
		(v, m/s = 1.0	1.0	3.2	0.6	3.8						
		1.5	1.5	3.1	0.8	3.8						
		2.0	2.0	2.9	0.9	3.8						
		2.5	2.5	2.7	1.1	3.8						
		3.1)	3.1)	2.6	1.2	3.8						
		35.0	38									
		(v, m/s = 1.0	1.0	3.8	0.1	3.8						
		1.5	1.5	3.6	0.2	3.9						
		2.0	2.0	3.5	0.4	3.9						
		2.5	2.5	3.3	0.5	3.8						
		3.1)	3.1)	3.1	0.6	3.7						
2.1	42d	29.0	52				400					
		(v, m/s = 1.0	1.0	2.6	1.2	3.8						
		1.5	1.5	2.6	1.5	4.0						
		2.0	2.0	2.5	1.8	4.2						
		2.5	2.5	2.4	2.1	4.5						
		3.1)	3.1)	2.3	2.4	4.7						
		32.0	45									
		(v, m/s = 1.0	1.0	3.3	0.4	3.7						
		1.5	1.5	3.1	0.5	3.6						
		2.0	2.0	3.0	0.6	3.7						
		2.5	2.5	2.9	0.8	3.7						
		3.1)	3.1)	2.9	0.9	3.8						

TABLE 1 (continued)

M (kg)	Age (d or wk)	T <sub>a</sub> (°C)	RH (%)	LHP	SHP	THP	No. birds	Duration	Light	Type	Waterer	[Ref., Yr]		
				(W/kg)										
2.1	42d	35.0 (v, m/s =	38				400	2.5h/d for 3d	no light	A/D	no water	[2, 1997]*		
				1.0	3.7	0.1							3.7	
				1.5	3.6	0.3							3.9	
				2.0	3.4	0.5							3.9	
				2.5	3.2	0.6							3.8	
		3.1)	3.0	0.7	3.7									
3.0	6.5wk	24.0	52	4.1	4.3	8.4	96	4d cont.	8h: L 4h: D 24h	A/I	nipple	[3, 1996]		
				3.2	3.1	6.3								
				3.8	3.9	7.7								
0.10	4d	28.3	50	13.7	2.3	16.1	26000 (6 flocks)	4-42d cont.	24h***	B/D	nipple	[4, 1996]* ##		
0.16	6d			14.3	5.5	19.8								
0.23	8d			12.1	5.8	18.0								
0.30	10d			25.6	50	10.4							6.1	16.5
0.40	12d			9.1	6.3	15.5								
0.46	14d			8.3	6.5	14.8								
0.54	16d			7.9	6.6	14.5								
0.60	18d	22.8	50	7.6	6.6	14.2								
0.75	21d	15.6	50	6.8	5.9	12.8								
1.07	28d			5.5	4.6	10.2								
1.41	35d			4.7	4.4	9.1								
1.80	42d			4.4	4.3	8.8								
0.75	21d	21.1	50	7.1	5.7	12.8								
1.07	28d			5.8	4.1	9.9								
1.41	35d			4.6	3.5	8.1								
1.80	42d			4.1	3.4	7.4								
0.75	21d	26.7	50	7.1	4.6	11.7								
1.07	28d			6.4	3.2	9.7								
1.41	35d			6.1	3.2	9.3								
1.80	42d			6.0	3.2	9.3								
0.05	2d	33.2	30	21.1	8.9	30.0	7535	1d/wk	cont.	B/D	bell	[5, 1984] (barn A)		
0.16	9d	27.7	41	8.3	5.4	13.7								
0.36	16d	26.6	38	6.2	3.7	9.8								
0.63	23d	24.3	43	5.4	5.0	10.4								
0.95	30d	22.6	41	5.4	6.3	11.7								
1.32	37d	21.8	58	4.1	5.0	9.1								
1.71	44d	21.6	48	4.4	4.9	9.3								

TABLE 1 (continued)

M	Age	T <sub>a</sub>	RH	LHP	SHP	THP	No. birds	Duration	Light	Type	Waterer	[Ref.,Yr]
(kg)	(d or wk)	(°C)	(%)	(W/kg)								
0.09	5d	30.4	23	6.5	5.2	11.8	6635	1d/wk	cont.	B/D	bell	[5,1984]
0.23	12d	28.2	28	6.1	9.4	15.4						(barn B)
0.47	19d	25.7	37	5.0	9.0	14.0						
0.76	26d	25.1	42	5.5	7.5	13.0						
1.11	33d	24.1	50	5.7	7.8	13.5						
1.49	40d	21.1	53	4.2	7.3	11.5						
0.1	7d	29.4	46	14.8	4.7	19.6	640	8h/d	cont.	A/D	jugs &	[6,1982]*
0.2	14d	26.7	53	10.9	6.2	17.1	320	for 4 wk			trough	
0.4	21d	23.9	57	8.0	6.7	14.7	160					
0.8	28d	21.1	52	7.1	6.5	14.1	80					
0.8	28d	15.6	58	6.5	5.5	12.1	640	4 wk	cont.	A/D	trough	[7,1982]*
1.2	35d		48	5.3	4.7	10.0	320	cont.				
1.6	42d		60	4.9	4.7	9.6	160					
2.0	49d		61	4.3	4.9	9.3	80					
0.8	28d	21.1	52	7.2	5.2	12.4	640					
1.1	35d		56	5.8	4.3	10.1	320					
1.5	42d		54	4.7	4.1	8.8	160					
1.9	49d		54	4.1	4.2	8.3	80					
0.7	28d	26.7	44	7.1	3.3	10.4	640					
1.1	35d		46	6.6	3.3	9.9	320					
1.5	42d		56	6.2	3.3	9.5	160					
1.8	49d		63	6.1	3.3	9.4	80					
0.5	21-28d	16±3	60	5.5	7.5	13.0	2100	5 wk	cont.	B/D	N/A	[8,1969]
0.8	29-35d		70	5.0	6.1	11.1		cont.				
1.1	36-42d		55	4.1	5.6	9.7						
1.3	43-49d		53	3.8	4.9	8.7						
1.5	50-56d		56	3.5	4.6	8.0						
0.5	21-28d	32-35	40-90	8.2	6.6	14.8	2100	5 wk	cont.	B/D	N/A	[9,1969]
0.7	29-35d		(ave. 70)	7.1	5.6	12.7		cont.				
0.9	36-42d			6.5	4.8	11.3						
1.1	43-49d			7.2	4.1	11.2						
1.4	50-56d			6.9	3.3	10.2						



**TABLE 1 (continued)**

M	Age	T <sub>s</sub>	RH	LHP	SHP	THP	No. birds	Duration	Light	Type	Waterer	[Ref..Yr]
(kg)	(d or wk)	(°C)	(%)	(W/kg)								
0.05	N/A	28.9	N/A	2.2	16.0	18.2	1200	N/A	24h***	C/D	fountain	[10.1968]*
0.09		28.9		2.8	13.4	16.2						
0.14		28.9		3.4	10.8	14.2						
0.36		25.0		2.6	9.4	12.1						
0.45	N/A	25.0	N/A	2.5	8.9	11.4						
0.54		25.0		2.3	8.3	10.7						
0.63		25.0		2.2	7.8	10.0						
0.72		25.0		2.1	7.2	9.3						
1.13	N/A	19.4	N/A	1.8	6.9	8.7	1200	N/A	24h***	C/D	fountain	[10.1968]*
1.35		19.4		1.6	6.3	7.9						
1.58		19.4		1.4	5.8	7.2						
1.80		19.4		1.2	5.3	6.4						
2.00		19.0		0.9	4.8	5.7						
0.6	32d	18.3	70	7.4	8.0	15.4	49	44d	Day	A/D	fountain	[11.1958]*
0.9	44d			6.6	6.7	13.3	49	cont.				
1.1	52d			6.2	6.0	12.2	35					
1.3	64d			5.6	5.2	10.8	35					
1.5	76d			5.2	4.5	9.7	34					
0.6	32d	18.3	70	5.7	7.4	13.0	49	44d	Night			
0.9	44d			5.1	6.0	11.0	49	cont.				
1.1	52d			4.8	5.2	10.0	35					
1.3	64d			4.4	4.3	8.7	35					
1.5	76d			4.1	3.5	7.6	34					
0.2	11d	29.4	70	9.4	5.6	14.9	69	65d	Day			
0.3	16d			8.7	5.1	13.7	69	cont.				
0.4	24d			7.9	4.6	12.5	69					
0.6	32d			7.4	4.3	11.6	50					
0.9	46d			6.7	3.8	10.5	50					
1.1	52d			6.4	3.7	10.1	50					
1.2	58d			6.2	3.5	9.8	35					
1.3	64d			6.1	3.4	9.4	35					
1.4	76d			5.7	3.2	8.9	35					

**TABLE 1 (continued)**

M	Age	T <sub>a</sub>	RH	LHP	SHP	THP	No. birds	Duration	Light	Type	Waterer	[Ref., Yr]
(kg)	(d or wk)	(°C)	(%)	(W/kg)								
0.2	11d	29.4	70	7.8	5.5	13.4	69	65d	Night	A/D	fountain	[11,1958]*
0.3	16d			7.2	4.9	12.2	69	cont.				
0.4	24d			6.5	4.4	10.9	69					
0.6	32d			6.1	4.0	10.1	50					
0.9	46d			5.5	3.4	8.9	50					
1.1	52d			5.3	3.3	8.5	50					
1.2	58d			5.1	3.1	8.2	35					
1.3	64d			5.0	3.0	7.9	35					
1.4	76d			4.7	2.7	7.4	35					

M = body mass, kg.; T<sub>a</sub> = air temperature, °C; T<sub>b</sub> = body core temperature, °C; RH = relative humidity, %

LHP = Latent Heat Production; MP(g/(h·kg)) = Moisture Production = LHP/h<sub>g</sub> where h<sub>g</sub> = latent heat of vaporization, kJ/kg

h<sub>g</sub> = 0.7 \* h<sub>g</sub>(T<sub>b</sub> = 41°C) + 0.3 \* h<sub>g</sub>(T<sub>a</sub>); e.g., h<sub>g</sub> = 2452 kJ/kg at T<sub>a</sub> = 21°C; SHP = Sensible Heat Production; THP = Total Heat Production

Type of study: A/I = Lab-scale indirect calorimetry & LHP values include evaporation of moisture from feces, litter & drinkers

A/D = Lab-scale direct calorimetry and LHP values include evaporation of moisture from feces, litter and drinkers

B/D = Whole-house direct calorimetry and LHP values include evaporation of moisture from feces, litter & drinkers

C/D = Lab-scale direct calorimetry and LHP values do not include evaporation of moisture from feces, litter and drinkers. Oil pans were used to submerge bird droppings

N/A = Information not available

\* = values calculated from regression equations (see Appendix 1) and converted to SI units as appropriate

\*\*\* = Source data presented as weighted average of light and dark periods

\*\* = The data presented were derived from data reported by Reece and Lott, 1982a

[1] Pedersen & Thomsen (2000); [2] Simmons et al. (1997); [3] Xin et al. (1996); [4] Gates et al. (1996); [5] Feddes et al. (1984);

[6] Reece and Lott (1982a); [7] Reece & Lott (1982b); [8] Deaton et al. (1969); [9] Reece et al. (1969); [10] Longhouse et al. (1968);

[11] Ota & Garver (1958).

**TABLE 2**  
**Summary of literature data on heat and moisture production of ad-lib fed (or otherwise noted) pullets and layers. Values in *italics* were calculated from the other two known HP variables (i.e., THP = LHP + SHP)**

Breed	M (kg)	Age (d or wk)	T <sub>a</sub> (°C)	RH (%)	LHP (W/kg)	SHP (W/kg)	THP (W/kg)	No. birds	Duration	Light	Type	Waterer	[Ref.,Yr]		
Hy-Line GP male chicks	0.037	0 - 3d	29.4	40±5	<i>11.1</i>	8.0	19.1	1280	3d cont.	Int.	A/I	Aqua-Jel	[1,2000]		
	0.0340	0-2d	35	17	3.2	5.2	8.4	2112	2d cont.	cont.	A/I <sup>mf</sup>	no water	[2,1996]		
			30	22	2.8	5.7	8.5								
			25	30	2.7	6.4	9.1								
20			40	2.5	7.8	10.3									
Shaver Starcross 288	1.7	52 wk	7 - 25	N/A	N/A	N/A	6.8	4	4d cont.	14h: L 10h: D 24h	A	bell	[3,1990]		
							4.6							5.9	
Dekalb XL Pullets	0.06	7d	27.2	<i>13 - 32</i>	5.7	11.4	<i>17.1</i>	2500	7 wk cont.	10h: L	B/D	bell	[4,1987]*		
	0.11	14d	24.4	<i>20 - 38</i>	4.4	11.1	<i>15.5</i>								
	0.18	21d	21.6	<i>29 - 43</i>	3.8	10.1	<i>13.9</i>								
	0.25	28d	21.0	<i>41 - 62</i>	3.6	9.2	<i>12.8</i>								
	0.33	35d	21.0	<i>40 - 61</i>	3.6	8.5	<i>12.1</i>								
	0.43	42d	21.0	<i>32 - 53</i>	3.6	7.9	<i>11.5</i>								
	0.54	50d	21.0	<i>36 - 53</i>	3.7	7.4	<i>11.1</i>								
	0.06	7d	27.2	<i>13 - 32</i>	5.2	-0.3	4.9							14h: D	
	0.11	14d	24.4	<i>20 - 38</i>	3.9	3.2	7.1								
	0.18	21d	21.6	<i>29 - 43</i>	3.3	4.2	7.5								
	0.25	28d	21.0	<i>41 - 62</i>	3.1	4.4	7.5								
	0.33	35d	21.0	<i>40 - 61</i>	3.0	4.4	7.4								
	0.43	42d	21.0	<i>32 - 53</i>	3.0	4.4	7.4								
	0.54	50d	21.0	<i>36 - 53</i>	3.0	4.3	7.3								
	0.06	7d	27.2	<i>13 - 32</i>	5.4	4.6	10.0								24h
	0.11	14d	24.4	<i>20 - 38</i>	4.1	6.5	10.6								
	0.18	21d	21.6	<i>29 - 43</i>	3.6	6.7	10.2								
	0.25	28d	21.0	<i>41 - 62</i>	3.3	6.4	9.8								
	0.33	35d	21.0	<i>40 - 61</i>	3.2	6.1	9.4								
	0.43	42d	21.0	<i>32 - 53</i>	3.2	5.9	9.1								
0.54	50d	21.0	<i>36 - 53</i>	3.3	5.6	8.9									

TABLE 2 (continued)

Breed	M (kg)	Age (d or wk)	T <sub>2</sub> (°C)	RH (%)	LHP	SHP	THP	No. birds	Duration	Light	Type	Waterer	[Ref.,Yr]
					(W/kg)								
Arbor Acres broiler breeders	3.6	31-57wk	17.5	55	2.9	3.4	6.4	11546	24h per 4wk	14h: L 10h: D 24h	B/D	bell	[5,1987]
					2.6	2.6	5.2						
					2.8	3.1	5.9						
		27-55wk	18.9	58	2.0	3.5	5.5	14h: L					
					1.9	2.9	4.8	10h: D					
					2.0	3.2	5.2	24h					
Arbor Acres broiler breeders	3.6	33-49wk	18.8	60	2.8	3.0	5.9	11546	24h per 4wk	14h: L 10h: D 24h	B/D	bell	[5,1987]
					2.6	3.1	5.7						
					2.7	3.1	5.8						
White Leghorn	1.8	44-58wk	20.0	68	4.1	5.4	9.5	144	7d cont.	16h: L 8h: D 24h	A/D	cup	[6,1986]
					2.9	4.1	7.0						
					3.7	4.9	8.6						
White Leghorn	1.7	44-58wk	21±5	73-54	4.3	6.8	11.1			16h: L 8h: D 24h			
					2.5	7.3	9.8						
					3.7	7.0	10.7						
White Leghorn	1.8	44-58wk	21±6	62-77	2.6	9.8	12.4			16h: L 8h: D 24h			
					2.8	7.5	10.3						
					2.6	9.0	11.6						
White Leghorn	1.7	31wk	19.0	63	4.6	4.4	9.0	48	7d cont.	16h: L 8h: D 24h	A/D	cup	[7,1985]
					4.4	1.5	5.9						
					4.5	2.8	7.3						
White Leghorn	1.7	31wk	20.0	80	3.7	3.2	6.9			16h: L 8h: D 24h			
					5.3	3.5	8.8						
					4.5	3.4	7.9						
White Leghorn	1.5	33wk	14.3	61	1.2	5	6.2	24850	24h cont. 6 times during	18h: L 6h: D 24h	B/D	cup	[8,1985]
					0.9	3.7	4.6						
					1.1	3.9	5.0						
White Leghorn	1.6	53wk	15.0	58	1.2	4.8	6.0	33-56wk	9.5h: L 4.5h: D 24h				
					1.1	4.3	5.4						
					1.2	4.3	5.5						

TABLE 2 (continued)

Breed	M (kg)	Age (d or wk)	T <sub>3</sub> (°C)	RH (%)	LHP	SHP	THP	No. birds	Duration	Light	Type	Waterer	[Ref.,Yr]	
					(W/kg)									
White Leghorn	1.7	56wk	15.4	49	1.1	4.5	5.6	24850	24h cont. 6 times during	20h: L 4h: D 24h	B/D	cup	[8,1985]	
					0.9	3.8	4.7							
					1.0	4.0	5.0							
Hy-Line W-36	1.67	41 wk	23.0	58	1.2	4.4	5.6	33-56wk	24h	C/D	cup	[9,1978]		
White Leghorn hybrid strain H & N' hens	1.62	58 wk	23	N/A	N/A	N/A	5.4	6	24h per age group	24h***	A/T <sup>ff</sup>	N/A	[10,1974]	
	1.63	62				4.9								
	1.69	78				4.7								
	1.84	90				5.3								
	1.93	102				4.9								
1.95	106				4.8									
White Leghorn hybrid strain H & N' cockerels	1.69	58 wk	23	N/A	N/A	N/A	2.6	6	24h per age group	24h***	A/T <sup>ff</sup>	N/A	[10,1974]	
	1.78	62				2.8								
	1.96	78				3.2								
	1.99	90				3.3								
	2.00	102				4.0								
2.01	106				3.8									
White Leghorn	1.61	26-48wk	17.8	70	1.8	4.5	6.3	10 per chamber	3wk per age goup	Day	C/D	fountain	[11,1961]	
	1.54	34-39wk	18.3	70	1.6	5.1	6.7							
	1.61	26-48wk	17.8	70	1.3	4.4	5.7							
New Hampshire × Cornish Cross	2.5	51-70wk	18.9	75	1.2	3.5	4.7	11 per chamber	3wk per age goup	Day				
	2.7		18.3	75	1.1	3.5	4.6							
	2.5		23.9	N/A	1.3	2.8	4.1							
	2.8	23.9	N/A	1.2	2.7	3.9								
	2.5	51-70wk	18.9	75	0.9	2.9	3.9							Night
	2.7		18.3	75	0.9	2.9	3.8							
	2.5		23.9	N/A	0.8	2.6	3.4							
2.8	23.9		N/A	0.7	2.5	3.2								

TABLE 2 (continued)

Breed	M (kg)	Age (d or wk)	T <sub>a</sub> (°C)	RH (%)	LHP	SHP	THP	No. birds	Duration	Light	Type	Waterer	[Ref.,Yr]
					(W/kg)								
Rhode Island Reds	2.48	37wk	-3.9	70	0.8	3.7	4.4	10 per chamber	3wk per age group	Day	C/D	fountain	[11,1961]
	2.55	43	-0.6	85	0.9	4.7	5.6						
	2.52	46	5.0	85	1.2	4.7	6.0						
	2.62	37	7.2	83	1.2	4.8	6.0						
	2.55	39	15.6	64-70	1.3	4.3	5.6						
	2.47	42	24.4	50-60	1.4	2.5	3.9						
	2.24	37	33.3	36-46	2.0	1.0	3.0						
Rhode Island Reds	2.48	37wk	-3.9	70	0.7	2.8	3.6			Night			
	2.55	43	-0.6	85	0.8	3.3	4.1						
	2.52	46	5.0	85	1.0	3.3	4.2						
	2.62	37	7.2	83	1.0	2.4	3.3						
	2.55	39	15.6	64-70	0.9	3.5	4.4						
	2.47	42	24.4	50-60	1.0	1.7	2.7						
	2.24	37	33.3	36-46	1.6	0.5	2.1						
Rhode Island Reds	2.3	N/A	5.5	88	2.7	4.1	6.8	20	25d cont.	24h***	A/D	fountain	[12,1953]
			13.9	76 - 89	3.0	3.4	6.4						
			29.8	57	3.8	0.6	4.4						

M = body mass, kg.; T<sub>a</sub> = air temperature, °C; T<sub>b</sub> = body core temperature, °C; RH = relative humidity, %

LHP = Latent Heat Production; MP(g/(h·kg)) = Moisture Production = LHP/h<sub>g</sub> where h<sub>g</sub> = latent heat of vaporization, kJ/kg

h<sub>g</sub> = 0.7·h<sub>g</sub>(T<sub>b</sub>=41°C) + 0.3·h<sub>g</sub>(T<sub>a</sub>); e.g., h<sub>g</sub> = 2452 kJ/kg at T<sub>a</sub> = 21°C; SHP = Sensible Heat Production; THP = Total Heat Production

Type of study: A/I = Lab-scale indirect calorimetry and LHP values include evaporation of moisture from feces, litter & drinkers

A/D = Lab-scale direct calorimetry and LHP values include evaporation of moisture from feces, litter and drinkers

B/D = Whole-house direct calorimetry and LHP values include evaporation of moisture from feces, litter & drinkers

C/D = Lab-scale direct calorimetry and LHP values do not include evaporation of moisture from feces, litter and drinkers.

Oil pans were used to submerge bird droppings

\* = values calculated from regression equations (see Appendix 2b) and converted to SI units as appropriate

\*\*\* = Source data presented as weighted average of light and dark periods; N/A = Information not available; nF = No feed

[1] Han & Xin (2000); [2] Xin & Harmon (1996); [3] Li et al. (1990); [4] Zulovich et al. (1987); [5] O'Connor et al. (1987);

[6] Dubensky et al. (1986); [7] Puri et al. (1985); [8] Feddes et al. (1985); [9] Riskowski et al. (1978); [10] O'Neill & Jackson (1974);

[11] Ota & McNally (1961); [12] Ota et al. (1953)

**TABLE 3**  
**Summary of literature data on heat and moisture production of ad-lib fed (or otherwise noted) turkeys. Values in *italics* were calculated from the other two known HP variables (i.e., THP = LHP + SHP)**

Breed	M (kg)	Age (d or wk)	T <sub>a</sub> (°C)	RH (%)	LHP	SHP	THP	No. birds	Duration	Light	Type	Waterer	[Ref.,Yr]							
					(W/kg)															
Nicholas toms	0.2	7d	29.4	35-60	<i>10.4</i>	2.3	12.7	332	35d	cont.	A/I	fountain	[1,1998]*							
	0.4	14d	28.3		<i>8.9</i>	5.0	13.9													
	0.7	21d	26.7		<i>7.3</i>	5.4	12.7													
	1.1	28d	23.9		<i>5.9</i>	4.8	10.7													
	1.7	35d	21.1		<i>4.8</i>	4.4	9.2													
Nicholas hens	6.8	15-16wk	32	60	1.6	1.3	2.9	72	210 min per trial	3.5h: L	A/I	cup	[2,1992]							
	7.1		32	80	1.1	1.9	3.0													
	6.8		36	51	2.3	1.0	3.3													
	7.4		36	68	1.7	1.8	3.5													
	6.5		40	43	3.2	0.8	4.1													
	7.4		40	58	2.3	2.0	4.3													
Large white hens	0.3	16d	27.2	38	8.7	1.3	10.0	4692	24h	cont.	B/D	automatic waterers	[3,1992]							
	0.7	21d	24.5	46	6.4	5.3	11.7													
	1.0	29d	22.2	66	6.8	4.8	11.6													
	1.5	36d	23.0	59	5.5	3.7	9.1													
	2.0	44d	19.6	66	5.6	4.8	10.3													
	3.1	57d	16.3	63	4.0	3.8	7.9													
	4.5	71d	17.8	47	2.9	4.0	6.8													
	6.6	79d	18.0	73	2.4	3.1	5.5													
	6.9	94d	16.3	52	2.0	2.3	4.3													
	toms	5.1	64d	14.0	68	1.6	2.5							4.2	2710	24h				
		5.9	70d	12.1	63	1.7	2.7							4.3						
		7.0	77d	12.8	70	3.0	3.0							5.9						
		7.8	84d	11.0	81	1.8	4.5							6.3						
8.8		92d	13.2	85	2.0	5.0	7.0													
10.0		99d	15.8	62	3.1	3.2	6.3													
11.1	106d	11.3	73	2.3	3.9	6.2														
Broad Breasted Bronze hens	9.8	41-63wk	10	60	0.2	2.1	2.3	4	2h	2h: L	A/D <sup>af</sup>	no water	[4,1977]							
	9.5		15	60	0.5	1.9	2.4													
	9.5		20	60	0.4	1.6	2.0													
	9.3		25	60	0.5	1.5	2.1													
	9.1		30	60	0.6	1.0	1.6													
8.7	35	60	0.8	0.6	1.4															

TABLE 3 (continued)

Breed	M (kg)	Age (d or wk)	T <sub>1</sub> (°C)	RH (%)	LHP	SHP	THP	No. birds	Duration	Light	Type	Waterer	[Ref.,Yr]
					(W/kg)								
Broad	17.2	41-63wk	10	60	0.2	1.9	2.1	4	2h	2h: L	A/D <sup>af</sup>	no water	[4,1977]
Breasted	17.4		15	60	0.3	1.7	2.0						
Bronze	16.8		20	60	0.4	1.6	2.1						
toms	16.5		25	60	0.6	1.5	2.1						
	16.8		30	60	0.7	0.8	1.5						
	15.8		35	60	1.0	0.4	1.4						
Wroldstad	0.6	28d	21±1	42±3	N/A	N/A	11.6	5	28-42d	12h: L	A/I	metal	[5,1974]*
white	0.9	35d					10.8						
toms	1.3	42d					10.2						
&													
hens	0.6	28d	21±1	42±3	N/A	N/A	7.9						
	0.9	35d					7.5						
	1.3	42d					7.2						
	0.6	28d	21±1	42±3	N/A	N/A	9.7						
	0.9	35d					9.2						
	1.3	42d					8.7						
	1.8	51d	21±1	42±3	N/A	N/A	9.3	5i-84d	cont.				
	2.2	58d					8.7						
	2.6	65d					8.2						
	3.0	72d					7.7						
	3.4	79d					7.2						
	3.6	84d					6.9						
Large	0.106	6d	35.0	N/A	11.9	5.0	16.7	10/chamber	24h	cont.	C/D	metal	[6,1974]
white male	0.111	7d	29.4		8.7	7.8	17.0						
Orlopp	0.129	9d	40.6		21.0	-2.1	18.4						
strain	0.235	14d	32.2		7.0	5.8	13.1						
	0.221	15d	37.8		11.0	1.6	12.1						
Large	0.364	19d	35.0	N/A	6.9	2.0	8.7	12/chamber	24h				
white male	0.419	21d	29.9		4.6	5.0	10.2						
Amerine	0.437	23d	23.9		4.0	7.1	11.1						
strain	0.568	27d	23.9		1.7	7.8	9.9						
	0.629	28d	26.7		2.8	6.0	8.7						
	0.740	29d	32.2		3.7	3.8	7.8						
	0.906	36d	29.4		2.6	4.4	7.3						



**TABLE 3 (continued)**

M = body mass, kg.;  $T_a$  = air temperature, °C;  $T_b$  = body core temperature, °C; RH = relative humidity, %

LHP = Latent Heat Production;  $MP(g/(h \cdot kg)) = \text{Moisture Production} = LHP/h_{fg}$  where  $h_{fg}$  = latent heat of vaporization, kJ/kg

$h_{fg} = 0.7 \cdot h_{fg}(T_b = 41^\circ\text{C}) + 0.3 \cdot h_{fg}(T_a)$ ; e.g.,  $h_{fg} = 2452$  kJ/kg at  $T_a = 21^\circ\text{C}$ ; SHP=Sensible Heat Production; THP=Total Heat Production

Type of study: A/I = Lab-scale indirect calorimetry and LHP values include evaporation of moisture from feces, litter & drinkers

A/D = Lab-scale direct calorimetry and LHP values include evaporation of moisture from feces, litter and drinkers

B/D = Whole-house direct calorimetry and LHP values include evaporation of moisture from feces, litter and drinkers

C/D = Lab-scale direct calorimetry and LHP values do not include evaporation of moisture from feces, litter and drinkers.

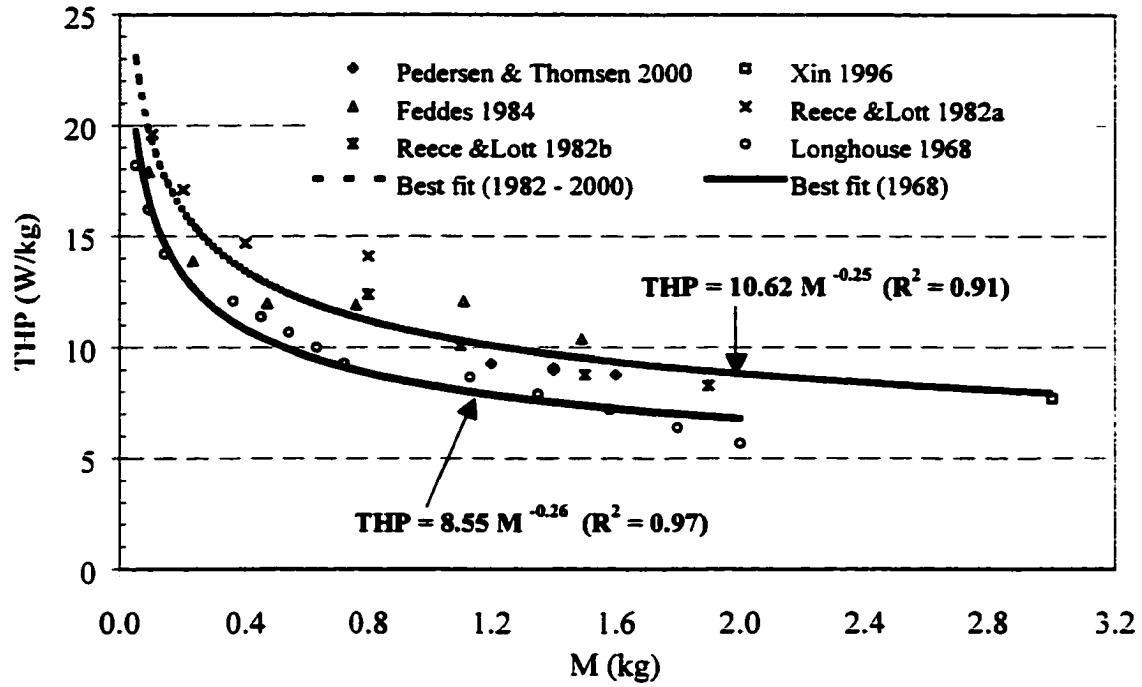
Oil pans were used to submerge bird droppings

N/A = Information not available; nf = No feed

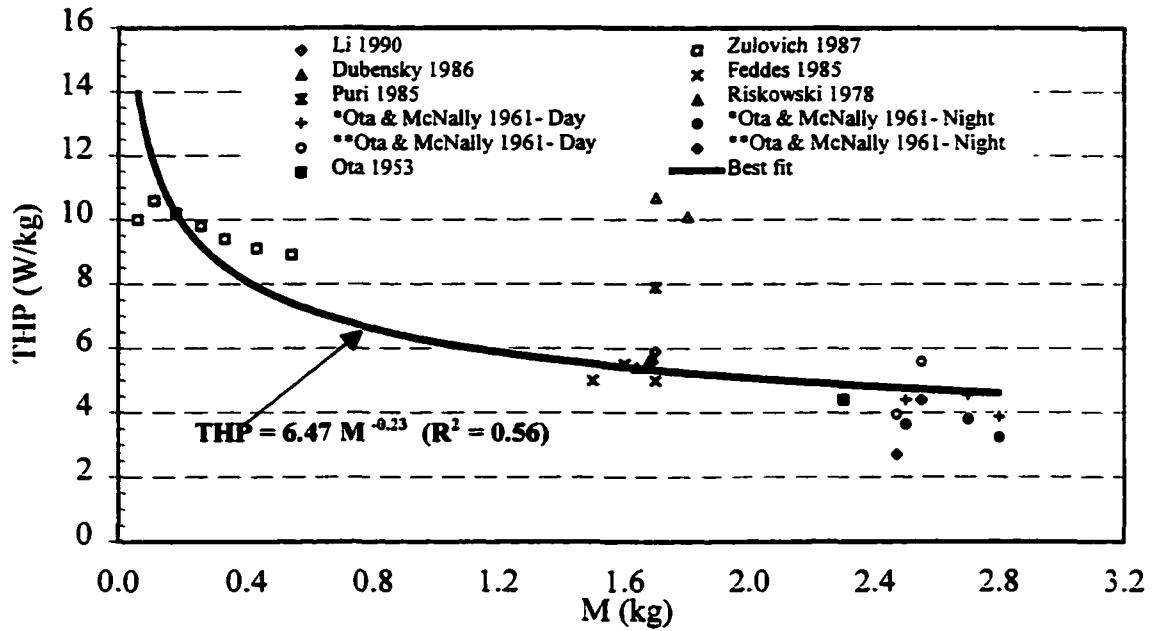
\* = values calculated from regression equations (see Appendix 3) and converted to SI units as appropriate

[1] Xin et al. (1998); [2] Xin et al. (1992); [3] Feddes & McDermott. (1992); [4] Shanklin et al. (1977); [5] Buffington et al. (1974)

[6] DeShazer et al. (1974)



**FIGURE 1.** Total heat production rate (THP) of broilers fed ad-libitum as a function of body mass (M) at thermoneutral environment (19-30°C), as measured over the past three decades.



**FIGURE 2. Total heat production rate (THP) of pullets and layers as a function of body mass (M) at thermoneutral environment (21-30°C), as measured during the past four decades. \* = New Hampshire; \*\* = Rhode Island Reds.**



## APPENDIX 1

Regression equations for calculating HP & MP for broilers as obtained from the literature sources

**Pedersen & Thomsen (2000)** [all HP values are in W/bird ; t = temperature, °C , M = bird mass, kg]

$$THP = 9.84 M^{0.75} (4 \times 10^{-5} (20 - t)^3 + 1)$$

$$SHP = 0.83 THP (0.8 - 1.85 \times 10^{-7} (t + 10)^4)$$

**Simmons et al. (1997)** [all HP values are in Btu/(hr-lb); air velocity, v = 200, 300, 400, 500, and 600 ft/min]

**For temperature of 29°C (85°F)**

5wk old birds

$$SHP = 1.26 + 0.0024v + 0.0000015v^2$$

$$LHP = 3.91 + 0.0042v - 0.0000088v^2$$

6wk old birds

$$SHP = 1.26 + 0.0027v + 0.0000022v^2$$

$$LHP = 4.01 + 0.00012v - 0.0000014v^2$$

**For temperature of 32°C (90°F)**

5wk old birds

$$SHP = 0.518 + 0.0023v - 0.000000088v^2$$

$$LHP = 5.31 - 0.0018v - 0.00000077v^2$$

6wk old birds

$$SHP = 0.222 + 0.0017v - 0.00000052v^2$$

$$LHP = 5.77 - 0.0041v + 0.0000031v^2$$

**For temperature of 35°C (95°F)**

5wk old birds

$$SHP = -0.618 + 0.004v - 0.0000024v^2$$

$$LHP = 6.17 - 0.0018v - 0.00000071v^2$$

6wk old birds

$$SHP = -0.921 + 0.0059v - 0.0000044v^2$$

$$LHP = 5.81 - 0.0016v + 0.0000031v^2$$

**Gates et al. (1996)** [all HP values are in Btu/(hr-lb) if K = 1, and W/kg if K = 0.64631; x = bird age, day]

**For all brooding temperatures**

$$SHP = K \exp(-6.5194 + 2.9186x - 0.24162x^2) \quad 3 \leq x \leq 5$$

$$SHP = K \exp(1.8662 + 0.054213x - 0.00161x^2) \quad 6 \leq x \leq 19$$

$$LHP = K (-42.961 + 27.415x - 2.84344x^2) \quad 2 \leq x < 5$$

$$LHP = K (36.424 - 2.8998x + 0.08676x^2) \quad 6 \leq x \leq 15$$

$$LHP = K (15.812 - 0.22611x) \quad 16 \leq x \leq 19$$

**For temperature of 15.6°C (60°F)**

$$SHP = K (38.612 - 2.6224x + 0.072047x^2 - 0.00066x^3) \quad 20 \leq x < 41$$

$$SHP = 6.717K \quad 42 \leq x \leq 48$$

$$LHP = K (22.285 - 0.78279x + 0.011503x^2 - 0.000038x^3) \quad 20 \leq x < 43$$

$$LHP = 6.87K \quad 44 \leq x \leq 48$$

**For temperature of 21.1°C (70°F)**

$$SHP = K (36.070 - 2.3107x + 0.058862x^2 - 0.00051x^3) \quad 20 \leq x < 39$$

$$SHP = 5.220K \quad 40 \leq x \leq 48$$

$$LHP = K (11.221 + 0.40495x - 0.02727x^2 + 0.000353x^3) \quad 20 \leq x < 43$$

$$LHP = 6.278K \quad 44 \leq x \leq 48$$

**For temperature of 26.7°C (80°F)**

$$SHP = K \exp(5.3611 - 0.16177x) \quad 20 \leq x < 23$$

$$SHP = 5.0K \quad 24 \leq x \leq 48$$

$$LHP = K (20.094 - 0.70318x + 0.015182x^2 - 0.000108x^3) \quad 20 \leq x < 42$$

$$\text{LHP} = 9.340\text{K}$$

$$43 \leq x \leq 48$$

**Reece & Lott (1982a)** [all HP values are in Btu/(hr-lb); MP = lb/(h-1000 birds); x = bird age, day]

$$\text{SHP} = 9.85 \text{ Log } x - 0.0043x^2 - 0.869 \quad 2 \leq x \leq 28$$

$$\text{LHP} = 8.6 + 3.4x - 0.009x^2 - 0.04x^3 + 0.0019x^4 \quad x < 13$$

$$\text{LHP} = 30.8 - 1.1x + 0.0005x^3 \quad x \geq 13$$

$$\text{MP} = 0.012x^2 + 0.53x + 0.63 \quad x \leq 7$$

$$\text{MP} = 0.00134x^3 - 0.047x^2 + 0.92x + 0.50 \quad x > 7$$

**Reece & Lott (1982b)** [all HP values are in Btu/(hr-lb) if K = 1, and Cal/(h-g) if K = 0.556; M = bird mass, g]

**For temperature of 15.6°C (60°F)**  $500 \leq M \leq 2000$

$$\text{SHP} = K(20.3 - 0.0247M + 1.498M^2 \times 10^{-5} - 2.95M^3 \times 10^{-9} + 2.2M^4 \times 10^{-14})$$

$$\text{LHP} = K(33.6 - 0.0605M + 5.455M^2 \times 10^{-5} - 2.21M^3 \times 10^{-8} + 3.29M^4 \times 10^{-12})$$

**For temperature of 21.1°C (70°F)**  $500 \leq M \leq 2000$

$$\text{SHP} = K(15.9 - 0.0143M + 4.96M^2 \times 10^{-6} + 1.02M^2 \times 10^{-9} - 6.47M^2 \times 10^{-13})$$

$$\text{LHP} = K(25.8 - 0.0382M + 3.752M^2 \times 10^{-5} - 1.9M^2 \times 10^{-8} + 3.69M^4 \times 10^{-12})$$

**For temperature of 26.7°C (80°F)**  $500 \leq M \leq 2000$

$$\text{SHP} = 5K$$

$$\text{LHP} = K(13 - 0.0034M + 4.57M^2 \times 10^{-7} + 1.74M^2 \times 10^{-10})$$

**Longhouse et al. (1968)** [all HP values are in Btu/(hr-lb); M = bird mass, lb]

**For temperature of 84°F (28.9°C)**  $0.1 \leq M \leq 0.3$

$$\text{SHP} = 28.57 - 40.02M \quad \text{LHP} = 2.43 + 9.42M$$

**For temperature of 77°F (25.0°C)**  $0.7 \leq M \leq 1.7$

$$\text{SHP} = 17.95 - 4.30M \quad \text{LHP} = 4.89 - 1.07M$$

**For temperature of 67°F (19.4°C)**  $2.1 \leq M \leq 4.4$

$$\text{SHP} = 14.53 - 1.60M \quad \text{LHP} = 4.45 - 0.67M$$

**Ota & Garver (1958)** [all HP values are in Btu/(hr-lb); x = bird age, day]

**For temperature of 18.3°C (65°F)**  $29 \leq x \leq 90$

$$\begin{aligned} \text{THP during day time:} & 58.37 - 23.10 \log x \\ \text{night time:} & 53.14 - 22.01 \log x \end{aligned}$$

$$\begin{aligned} \text{SHP during day time:} & 33.38 - 14.04 \log x \\ \text{night time:} & 35.23 - 15.84 \log x \end{aligned}$$

$$\begin{aligned} \text{LHP during day time:} & 25.12 - 9.13 \log x \\ \text{night time:} & 18.17 - 6.31 \log x \end{aligned}$$

**For temperature 29.4°C (85°F)**  $10 \leq x \leq 90$

$$\begin{aligned} \text{THP during day time:} & 34.20 - 10.90 \log x \\ \text{night time:} & 31.95 - 10.97 \log x \end{aligned}$$

$$\begin{aligned} \text{SHP during day time:} & 13.23 - 4.44 \log x \\ \text{night time:} & 13.60 - 5.00 \log x \end{aligned}$$

$$\begin{aligned} \text{LHP during day time:} & 21.34 - 6.67 \log x \\ \text{night time:} & 17.80 - 5.63 \log x \end{aligned}$$

## APPENDIX 2

Regression equations for calculating HP & M for pullets as obtained from the literature sources

**Zulovich et al. (1987)** [all HP values are in kJ/(hr-bird); x = bird age, day]

**For light periods**  $0 \leq x \leq 50$

$$\text{SHP} = 0.274x + 0.662 \quad \text{LHP} = 1.89 \times 10^{-3}x^2 + 2.82 \times 10^{-2}x + 1.01$$

**For dark periods**  $0 \leq x \leq 50$

$$\text{SHP} = 0.193x - 1.410$$

$$\text{LHP} = 1.40 \times 10^{-3}x^2 + 2.81 \times 10^{-2}x + 0.908$$

$$\text{M (g/bird)} = 28.94 + 3.66x + 0.18x^2 - 1.00 \times 10^{-3}x^3 \quad 0 \leq x \leq 50$$

## APPENDIX 3

Regression equations for calculating HP, MP & M for turkeys as obtained from the literature sources

**Xin et al. (1998)** [all HP values are in W/kg; MP = g/(h-kg); M = bird mass, g; x = bird age, day]

$$\text{THP} = 7.155 \times 10^{-4}x^3 - 5.4102 \times 10^{-2}x^2 + 1.0605x + 7.70 \quad 1 \leq x \leq 35$$

$$\text{SHP} = 6.296 \times 10^{-4}x^3 - 4.9979 \times 10^{-2}x^2 + 1.2164x - 3.94 \quad 1 \leq x \leq 35$$

$$\text{MP} = -0.3027x + 17.26 \quad 1 \leq x \leq 35$$

$$\text{M} = 0.0109x^3 + 0.7124x^2 + 10.057x + 55.6 \quad 1 \leq x \leq 35$$

As a function of body mass, M (kg):

$$\text{THP} = \frac{11.335}{M^{(0.1624 \ln(M)) + 0.3517}}$$

$$\text{MP} = \frac{9.167}{M^{(0.0742 \ln(M)) + 0.4197}}$$

$$\text{SHP} = 4.888 \ln(M) + 10.80 \quad M < 0.125$$

$$\text{SHP} = 4.7655 M^{(0.2731 \ln(M))^2 + 0.1138 \ln(M) - 0.2392} \quad M \geq 0.125$$

**Buffington et al. (1974)** [all HP values are in kcal/(kg-hr); x = bird age, day]

**For the light period**

$$\text{THP} = 12.9 \exp(-0.0093x) \quad 28 \leq x \leq 43$$

**For the dark period**

$$\text{THP} = 8.2 \exp(-0.0068x) \quad 28 \leq x \leq 43$$

**THP, (kcal/(hr-bird)) as a function of x:**

$$\text{THP} = 12.9 \exp(-0.0093x) \times (5.91 \exp(-4.736 \exp(-0.0271x))) \quad 50 \leq x \leq 84$$

$$\text{M (kg/bird)} = 5.91 \exp(-4.736 \exp(-0.0271x)) \quad 28 \leq x \leq 84$$

**CHAPTER 3.****HEAT AND MOISTURE PRODUCTION OF POULTRY AND THEIR  
HOUSING SYSTEMS: *PULLETS AND LAYERS***

A paper submitted to the Transactions of the American Society of Heating Refrigerating and  
Air-conditioning Engineers (ASHRAE)

H. J. Chepete, H. Xin, R. S. Gates, and M. C. Puma

**ABSTRACT**

Heat and moisture production rates (HP, MP) of modern pullets and laying hens were measured using large-scale indirect calorimeters that mimic commercial production settings. The birds measured included Hy-Line W-36 strain at 1-5, 10, 21, 37 and 64 weeks of age and W-98 strain at 1-5 weeks of age. Total HP (THP) was partitioned into latent and sensible HP (LHP, SHP) for the *bird* (excluding moisture evaporation from feces) or the *room* (including fecal moisture evaporation from feces). The W-98 or W-36 pullets reached the metabolic peak at 10 or 14 days of age, respectively. The W-98 pullet produced higher THP than the W-36 counterpart. Modern pullets showed higher THP (12-37%) than those reared 20 to 50 years ago. At the beginning of egg production, THP of the modern layers was 12% higher than that predicted by the CIGR (1999) model and the difference diminished with time. Evaporation of fecal moisture elevated *room* LHP by an average of 14% (8-38%, light period) or 43% (21-79%, dark period) and reduced the *room* SHP by an average of 11% (4-17%, light) or 22% (14-33%, dark) with reference to *bird* LHP or SHP. All HP responses



were significantly ( $P < 0.05$ ) reduced to various degrees (e.g., 23-34% for THP) in the dark as compared to the light period. Diurnal *bird or room* LHP as percentage of THP averaged 47% (17-87%) or 62% (33-99%), respectively, with corresponding RQ of 0.92 (0.77-1.18) for pullets. The corresponding values for laying hens averaged 39% (29-50%) or 45% (29-55%) with RQ of 0.90 (0.68-1.02). Regression models that relate daily mean THP, LHP and SHP of the *bird or room* to bird body mass were developed. Results of this study provide an updated thermal load database for design and operation of poultry housing ventilation systems, as well as bioenergetics information for the scientific literature.

**KEYWORDS:** Indirect calorimetry, Thermal load, Ventilation, Bioenergetics

## **INTRODUCTION**

Heat and moisture production rates (HP, MP) of animals and their surroundings are the basis for effective design and operation of environmental control systems of production facilities. HP and MP are subject to the influence of animal genetics, nutrition, housing scheme, equipment and management practices all of which have witnessed significant advancement over the years (Reece and Lott, 1982a,b; Gates et al., 1996; Xin et al., 1998). For instance, Havenstein et al. (1991) reported an increase in growth rate in modern chicken of about 350% compared with that of those in 1957. The sensible HP (SHP) and MP of a facility housing broiler chickens raised on litter was found by Reece and Lott (1982a) to be, respectively, much lower and higher than SHP and MP reported from earlier calorimetric studies in the literature. Photoperiod has been shown to have significant impacts on HP and MP of poultry (Riskowski et al., 1977; Zulovich et al., 1987; and Xin et al., 1996).

An extensive literature review of HP and MP of poultry (pullets, layers, broilers, and turkeys) and their housing systems recently performed by Chepete and Xin (2002) revealed

that most HP and MP data in the literature are 20 to 50 years old and that considerable gaps exist in the data for certain species or production stages. For example, the only data documented for pullets covered the growth period of 1 to 7 weeks of age (Zulovich et al., 1987), and there were no data for pullets and layers between 7 and 33 weeks of age. The result further confirmed the need to systematically update the HP and MP characteristics of modern poultry for the design and operation of environment-controlled poultry housing, as had been suggested by Gates et al. (1996), Xin et al. (1998), and ASHRAE Handbook (2001).

This study was part of the effort toward accomplishing the aforementioned need. The specific objectives of this study were 1) to measure HP and MP of pullets and layers using large-scale indirect calorimeters that mimic the commercial production settings with respect to thermal environment, stocking density, feeding and water scheme, photoperiod, and manure handling practices; 2) to compare the results with those currently available in the literature; 3) to evaluate the contribution of fecal and surrounding moisture sources to the MP of the room by separately quantifying latent HP of the *bird* vs. the *room*; and 4) to establish functional relationships between HP and MP and bird body mass.

## **MATERIALS AND METHODS**

### **Bird Handling and Management**

The Iowa State University (ISU) indirect calorimeter system, consisting of four calorimeter chambers as described by Xin et al. (1998), was used for this study. In particular, the gas (O<sub>2</sub> and CO<sub>2</sub>) analyzers were calibrated daily throughout the measurement periods to ensure measurement accuracy of  $\pm 0.5$  watt per chamber ( $>65$  watt output). In each trial performed for both pullets and layers, two randomly selected chambers had oil in the metal

pans placed under each cage compartment to submerge the feces. The oil prevented the evaporation of fecal moisture and thus allowed measurement of HP and MP from the birds only. The other two calorimeters had no oil in the pans, and thus the MP would include that from both the birds and their housing components (i.e., litter and fecal matter). Manure was removed from all chambers twice weekly, after which oil was replenished to ensure complete submergence of the feces. Birds were group-weighted weekly throughout the trial, so that regression models could be established and used for calculation of the specific HP and MP.

Bird mortality was continuously monitored and was excluded from the determination of total body mass for calculation of the specific HP and MP. The commercial management practices (feeding, photoperiod, temperature, stocking density, and manure handling) were followed throughout all the trials, as described below. At the end of each trial, the calorimeter chambers and control equipment were cleaned, disinfected, maintained (as needed), and not used for a week or longer before the next trial.

### **HP and MP Measurements**

**Pullets.** Two separate groups of Hy-Line W-36 and W-98 pullets were measured in the pullet study, each over a 1- to 5-week growth period. Each group, consisting of 720 chicks, was delivered to the ISU Livestock Environment and Animal Physiology (LEAP) Laboratory in Ames from the hatchery (Hy-Line International, Spencer, IA). Upon arrival, the chicks were group-weighted and randomly allocated to the four indirect calorimeter chambers. Each chamber had a movable supporting stand with nine cages (55L × 50W × 41H cm each). Twenty day-old chicks were initially allocated to each cage and were thinned down to 15 and 10 during the start of week 3 and 4, respectively, which corresponds to 180,

135, and 90 birds per chamber, respectively. These bird numbers ensured sufficient changes in air composition (O<sub>2</sub> and CO<sub>2</sub>) for the instruments to make accurate measurements.

Thermoneutral (TN) air temperature was applied to all chambers during the growth period. Specifically, the temperature was kept at 32°C during the first 2 days and was reduced by 1°C every 3 days thereafter until 21°C, where it remained constant. The corresponding relative humidity (RH) ranged from 35 to 50% throughout the trial. The chicks were exposed to continuous lighting for the first 2 days, then 15hL:9hD until 2-week old and thereafter 12hL:12hD up to 5 weeks of age when the trial was terminated. Light intensity was 16-21 lux (1.5 to 2.0 footcandle) for the first 2 days and 5-11 lux (0.5 to 1.0 footcandle) from the third day to the end of experiment. Chicks had free access to feed and water through nipple drinkers. Both W-36 and W-98 pullets were fed a prestarter ration during the first week and thereafter the starter ration (table 1).

To bridge the gap in the literature data, HP and MP of W-36 pullet at 10 weeks of age were measured, involving a total of 324 birds. The pullets were group-weighed and randomly allocated to the calorimeters with 81 birds per chamber (9 birds per cage). The measurement lasted for 4 weeks. The room temperature was 22°C during the first week, 28°C during the second and part of the third week, and back to 22°C during part of the third and the fourth week. Light intensity was 5-11 lux throughout the trial period. RH varied from 35 to 50% the entire time. Photoperiod was 12hL:12hD. The birds had free access to feed (table 1) and nipple drinkers.

**Laying hens.** HP and MP were measured on W-36 laying hens at 21, 37, and 64 weeks of age. The age groups were selected to reflect the various production stages of the birds. Each age group was studied over a 3-week period. The temperature regimen was 24°C

(TN), 30°C (warm), and back to 24°C during the first, second and third week, respectively. Only data associated with the first week are presented in this paper. Each age group involved a total of 252 hens, procured from commercial farms in Iowa, that were randomly allocated to the calorimeter chambers with 63 birds per chamber (or 7 hens per cage). RH was 35-50% the entire time. Photoperiod was 13hL:11hD, 16hL:8hD, and 16hL:8hD, respectively, for 21-, 37-, and 63-week old birds, respectively, at intensity of 5-11 lux. Eggs were collected twice daily to minimize breakage, which would otherwise interfere with MP measurement. The hens had free access to feed (table 1) and water through nipple drinkers.

### **Data Analysis and Presentation**

For each 24-h period of the trials, the data were separated into dark and light periods and their time-weighted averages (TWA) determined. The total HP (THP) data were further partitioned into latent HP (LHP) and SHP of the *bird* or the *room*, as described above. The data were subjected to analysis of variance (ANOVA) using Statistical Analysis Software (SAS) (SAS Institute, Inc. 1999-2000). Regression models were developed using Sigma Plot 2001 software (SPSS, Inc.) to relate the HP responses to body mass (M) of the *bird* or *room* (LHP and SHP) for TWA conditions.

HP and MP data of pullets during the first 2 days after hatching and the first day for the 10- to 64-week old birds were excluded in the development of the models as the birds were acclimating to the new environment. Data collected during cleaning and weighing of the birds were also excluded from the analysis.

### **RESULTS AND DISCUSSION**

The regression models of body mass (M, kg) vs. age (D, day) of the birds had the following forms:

For W-98 pullets ( $3 \leq D \leq 35$ ),

$$M = 1.46 \times 10^{-4} D^2 + 3.71 \times 10^{-3} D + 0.0295 \quad (R^2 = 1.000) \quad (1)$$

For W-36 birds ( $3 \leq D \leq 448$ ),

$$M = -1.65 \times 10^{-5} D^2 + 0.0106D + 0.0155 \quad (R^2 = 0.974) \quad (2)$$

These relationships are graphically shown in the presentation of THP, LHP and SHP as a function of M.

THP, LHP, SHP and respiratory quotient (RQ,  $CO_2/O_2$ ) of the *bird* and *room* (LHP and SHP) under light, dark and TWA conditions at various growth and production stages are summarized in table 2. There was no significant difference in THP between the calorimeters with or without oil ( $P > 0.52$ ). Thus, pooled THP values among the four calorimeters were used in the analysis.

The THP regression models developed were in the form of  $THP = aM^b$  and are presented in table 3. Selection of the THP model form was based on the physiological phenomenon that metabolic rate is directly proportional to M raised to a certain power or metabolic mass unit (Brody, 1945). LHP and SHP regression models were quadratic polynomials in the form of LHP or SHP (W/kg) =  $aM^2 + bM + c$ , and are presented as *bird* or *room* values in tables 4 and 5, respectively. The numerical differences in LHP or SHP between the table values and those derived from regression models were inevitable. For design purposes, use of the table values (e.g., table 2) is recommended, whenever possible.

The contribution of feces and other surrounding elements to the elevation of *room* LHP and reduction of *room* SHP can be noted for various growth and production stages in figures 1 and 2. While the *bird* LHP and SHP provide insights into delineation of

thermoregulation, the *room* LHP and SHP are the basis for design and operation of the housing ventilation system.

### **Metabolic Peak Period**

During the initial stages of growth after hatching, specific THP of the pullets increased progressively and reached its peak at certain age (fig. 1 for W-98 and fig. 2 for W-36). This period is known as the “metabolic peak period” (Brody, 1945). The W-98 pullet reached the metabolic peak (17.8 W/kg) at 10 days of age while the W-36 counterpart reached the peak (15.4 W/kg) at 14 days of age (table 2). This result parallels reports from the industry that the W-98 pullet reaches maturity at an earlier age than the W-36. The W-98 birds begin egg production at an earlier age (16 to 17 weeks) when compared to the W-36 which begins at 18 to 19 weeks (Hy-Line W-36 Commercial Management Guide, 2000-2001). During this peak period, the W-98 pullet produced higher THP ranging from 16.0 to 17.8 W/kg while that of the W-36 ranged from 12.8 to 15.4 W/kg. Figure 2 shows a somewhat higher metabolic peak for W-36 pullet. This is a result of curve-fitting artifact while making the two curves meet. However, for W-98 (fig. 1), the two curves fitted well.

LHP steadily increased to a maximum by 6 days of age for both W-98 and W-36 pullets and then declined while SHP increased sharply for both species prior to the metabolic peak. This may have resulted from increased metabolic rate as the pullets physiologically develop. SHP for the W-98 continued to rise slightly after metabolic peak while W-36 declined (figs. 1 and 2). This may have contributed to the higher overall THP for the W-98 pullet. LHP curves were not fitted during this period (fig. 1 and 2) and may be obtained by difference between THP and SHP.

### **Post Metabolic Peak Period**

**THP (W-98 pullet, 10 to 35 d).** The TWA THP of the W-98 pullet during 10- to 35-d growth period ranged from 12.2 W/kg (0.33 kg) to 17.8 W/kg (0.07 kg) (table 2). In comparison, calculations of the pullet THP using the CIGR Handbook (1999) equation,  $\text{THP (W/kg)} = 6.28M^{-0.24}$ , gave a corresponding THP of 8.2 and 11.9 W/kg. This result indicates that the W-98 pullet produce 49% higher THP than what the CIGR model would predict. When compared with the data reported by Zulovich et al. (1987) for Dekalb XL pullet at 14 to 35 d of age (0.11 to 0.33 kg), the W-98 pullet showed 30 to 48% higher THP.

During this period, THP was significantly reduced ( $P < 0.05$ ) by 21 to 36% when switching from light to darkness. In comparison, THP for the Dekalb XL pullets derived from the study by Zulovich et al. (1987) showed 39-54% reduction during the 14- to 35-d growth period.

**THP (W-36 pullet and laying hens, 14 to 448 d).** Comparison of the new model of  $\text{THP [W/bird]} = 7.64M^{0.65}$  from this study (table 3) with the model established by Chepete and Xin (2002) of  $\text{THP [W/bird]} = 6.47M^{0.77}$  based on data from 1953 to 1990 (figure 3) indicates that modern birds have higher THP than those reared in the past. The average THP for pullets of  $M = 0.09$  to 1.36 kg ranged from 0.8 to 6.5 W/kg (12-37%) higher for the modern pullet. The higher THP in the modern birds is speculated to result from improved genetics, bird nutrition, and management practices.

Further comparison was made with the CIGR Handbook (1999) model,  $\text{THP [W/bird]} = 6.28M^{0.76} + 25Y$ , where  $Y = \text{egg production, kg/d-hen}$  (fig. 3).  $Y$  was derived from the performance data in the Hy-Line W-36 Commercial Management Guide (HLI,



2000-2001), having the form of  $Y \text{ [kg/d-hen]} = -36.07M^3 + 156.17M^2 - 224.84M + 107.67$  for  $M = 1.36$  to  $1.53$  kg ( $R^2 = 0.997$ ). For pullets of  $M = 0.09$  to  $1.36$  kg (post metabolic peak period),  $Y = 0$ , the model of this study showed  $1.0$  to  $6.6$  W/kg or  $15$ - $37\%$  higher THP than that predicted by the CIGR model. On the other hand, for laying hens of  $M = 1.36$  to  $1.53$  kg, the new model was  $12\%$  higher at the start of egg production ( $1.36$  kg) and the difference became negligible with time. The THP curvature of the CIGR model for  $M = 1.40$  to  $1.53$  kg (fig. 3) was a result of egg production profile of the hen (i.e., reaches peak and then declines). The slightly higher THP values for the CIGR model during this period could have resulted from use of egg production that was higher than the actual value. Statistical comparisons of the models could not be performed due to differences inherent in the data used in development of each model which includes, among others, time of study, bird genetics, management practices, and feed used.

The daily TWA THP of this study ranged from  $6.5$  ( $1.40$  kg) to  $15.4$  ( $0.09$  kg) W/kg and was  $23$ - $34\%$  lower in the dark than in light period (table 2). Li et al. (1991), MacLeod and Jewitt (1984), and Riskowski et al. (1977) reported THP reduction of  $33$ ,  $35$ , and  $22\%$ , respectively, in dark period. The greater THP in the light period is attributed to bird physical activity (Li et al., 1991; Feddes et al., 1985; and Brody, 1945) and posture (Li et al., 1991).

Riskowski (1978) and Feddes et al. (1985) respectively reported THP of  $5.6$  W/kg for Hy-Line W-36 laying hens at  $1.7$  kg and of  $5.0$  W/kg for White Leghorn hens at  $1.50$  kg. The W-36 bird at  $1.53$  kg in the current study had an average THP of  $6.7$  W/kg. Ota and McNally (1961) found THP of  $5.7$  W/kg for  $1.54$  kg (37-week old) White Leghorn hens during the light period, as compared to  $7.8$  W/kg for the W-36 hen of the same age (37-week) but

slightly higher M (1.48 kg in this study), or 7.3 W/kg for W-36 hen of similar M (1.53 kg). Changes in bird genetics, nutrition, and productivity level may have contributed to the aforementioned THP differences. Due to the gap in HP data in the literature (Chepete and Xin, 2002), comparison of HP values of birds at 10 and 21 weeks of age under TN conditions could not be made.

**LHP (W-98 pullet).** *Bird* LHP ranged from 4.9 (0.33 kg) to 10.7 (0.07 kg) W/kg during the light period, and from 2.5 to 6.4 at the same M during the dark period (table 2). *Bird* LHP was significantly reduced ( $P < 0.05$ ) upon transition from light to dark period by 37-49%.

The corresponding *room* LHP ranged from 5.5 to 12.0 W/kg during the light period and from 3.9 to 9.1 W/kg during the dark period. Compared to the W-36 pullet at 10- to 35-d of age (table 2), the W-98 generally produced higher LHP and this was consistent with the field observation that the W-98 birds drink more water and thus have wetter droppings. However, moisture content of the manure was not monitored in the current study. *Room* LHP was significantly reduced ( $P < 0.05$ ) upon transition from light to dark period by 20-33%. *Room* LHP for Dekalb XL pullets at 7- to 35-d of age derived from the study by Zulovich et al. (1987) was reduced by 9-17% when transiting from light to dark.

With reference to *bird* LHP, moisture evaporation from feces increased *room* LHP by 8-23% during the light period and by 36-61% during the dark period. Contribution of fecal moisture evaporation to *room* LHP was greater during the dark than light period presumably because of the reduced LHP from the bird in the dark, particularly activity related LHP, while LHP from the manure remained relatively constant. Puma et al. (2001), May and Lott (1994), and Xin et al. (1993) indicated that birds tend to feed and drink more

rigorously just before lights turn off (anticipatory feeding and drinking) and this may result in increased defecation during the dark period.

**LHP (W-36 pullet and laying hens).** *Bird* LHP ranged from 2.4 (0.81 kg) to 8.5 (0.09 kg) W/kg during the light period and from 1.7 (0.81 kg) to 5.1 (0.18 kg) W/kg during the dark period. *Bird* LHP was significantly reduced ( $P<0.05$ ) by 26-42% when switching from light to dark. In particular, the W-36 hens at 37 weeks of age (1.5 kg) showed *bird* LHP reduction of 34% when switching from light to dark. This value compared well with the reduction of 28-31% derived from the study by Ota and McNally (1961) for White Leghorn laying hens averaging 37 weeks of age (1.6 kg). TWA *bird* LHP was 2.8 W/kg for 1.53 kg birds of this study while Riskowski (1978) reported a value of 1.2 W/kg for 1.7 kg Hy-Line W-36 birds.

The *room* LHP during this period ranged from 3.0 (1.40 kg) to 9.2 (0.09 kg) W/kg during the light period and 2.3 (1.40 kg) to 6.8 (0.18 kg) W/kg during the dark period. *Room* LHP was significantly reduced ( $P<0.05$ ) by 15-29% when switching from light to dark. Moisture evaporation from feces increased *room* LHP by 8-38% (averaging 18%) and 21-79% (averaging 43%) during the light and dark period, respectively.

**SHP (W-98 pullet).** *Bird* SHP ranged from 8.7 (0.07 kg) to 10.9 (0.17 kg) W/kg during the light period, and from 7.3 (0.33 kg) to 8.9 (0.07 kg) W/kg during the dark period. *Bird* SHP was significantly reduced ( $P<0.05$ ) by 15-28% upon transition from light to dark period during the 14- to 35-d growth period and was correspondingly increased by 2 to 36%.

*Room* SHP ranged from 7.4 (0.07 kg) to 9.3 (0.17 kg) W/kg during the light period and from 5.6 (0.09 kg) to 6.2 (0.07 kg) W/kg during the dark period. *Room* SHP was significantly reduced ( $P<0.05$ ) by 16-39% upon transition from light to dark period. *Room*

SHP derived from data by Zulovich et al. (1987) for Dekalb XL pullets at 14- to 35-d of age (0.11-0.33 kg) was reduced by 48-71% when changing from light to dark. Han and Xin (2000) reported a 21-27% reduction in THP, *room* LHP, and SHP for 3-d old Hy-Line GP male chicks when switching from light to dark period. With reference to *bird* SHP, moisture evaporation from feces reduced *room* SHP by 6-15% (averaging 11%) during the light period and by 19-30% (averaging 26%) during the dark period.

***SHP (W-36 pullet and laying hens).*** *Bird* SHP ranged from 4.4 (1.53 kg) to 9.9 (0.18 kg) W/kg during the light period and 3.4 (1.48 kg) to 7.4 (0.09 kg) W/kg during the dark period. *Bird* SHP was significantly reduced ( $P < 0.05$ ) by 16-36% when switching from light to dark. A 26% reduction of *bird* SHP was observed on 37-week old birds (1.5 kg) of this study when changing from light to dark. In comparison, data reported by Ota and McNally (1961) for White Leghorn laying hens of the same average age (1.6 kg) revealed 2-10% reduction. TWA *bird* SHP of this study was 4.0 W/kg for 1.53 kg birds while Riskowski (1978) reported a value of 4.4 W/kg for 1.7 kg Hy-Line W-36 birds.

The *room* SHP ranged from 4.0 (1.53 kg) to 8.7 (0.18 kg) W/kg during the light period and from 2.7 (1.53 kg) to 5.7 (0.09 kg) W/kg during the dark period. *Room* SHP was significantly reduced ( $P < 0.05$ ) by 27-47% when switching from light to dark. Moisture evaporation from feces reduced *room* SHP by 4-17% (averaging 11%) during the light period, and by 14-33% (averaging 22%) during the dark period. O'Connor et al. (1997) and Feddes et al. (1985) reported *room* SHP reduction of 18-34% and 4-8%, respectively, as a result of SHP conversion into *room* LHP for 3.6 kg Arbor Acres broiler breeders (O'Connor et al.) and White Leghorn laying hens (Feddes et al.) both raised in commercial barns.

## RQ

The RQ values at the selected M are presented in table 2. RQ varied from 0.88 to 1.02 (averaging 0.94) for pullets at 3- to 70-d of age and from 0.88 to 0.96 (averaging 0.91) for laying hens at 21- to 64-week of age. Ketelaars et al. (1985) reported an RQ of 0.92 for laying hens at normal production. Ouwerkerk and Pedersen (1994) mentioned that RQ varies depending on the metabolic rate, feed intake and individual status of the animal, adding that it increases with feed intake.

## Diurnal HP and MP profiles

Diurnal HP, MP or LHP and RQ profiles for selected trials are shown in figures 4 through 9. LHP of the *bird* ( $LHP_{bird}$ ) or *room* ( $LHP_{room}$ ) has been expressed as a percentage of THP. *Bird* or *room* LHP as percentage of THP ranged from 17 to 87% (averaging 47%) or 33 to 99% (averaging 62%), respectively, with a corresponding RQ of 0.77 to 1.18 (averaging 0.92) for pullets at 4 days and 10 weeks of age. The corresponding values for laying hens at 21 to 64 weeks of age ranged from 29 to 50% (averaging 39%) or 29 to 55% (averaging 45%) with RQ of 0.68 to 1.02 (averaging 0.90). The higher HP and RQ values for pullets as compared to laying hens may be a result of rigorous growth and development of the pullets resulting in high specific HP. HP was higher when the light was *on* than when it was *off* probably because of increased bird physical activity that has been reported to increase THP by up to 25% (Boshouwers and Nicaise, 1985).

## CONCLUSIONS

Heat and moisture production (HP and MP) of modern pullets (W-36 and W-98 strains) and laying hens (W-36 strain) were measured using large-scale indirect calorimeters.

Latent HP (LHP) and sensible HP (SHP) were expressed as those of *bird* or *room*. The following conclusions were drawn.

- Total HP (THP) values of modern pullets were 12-37% higher than that of pullets 20-50 years ago. On the other hand, THP of modern W-36 laying hens was 12% higher than the CIGR model (1999) at the onset of egg production and the difference became negligible with time.
- The W-98 pullet produced higher THP than the W-36 counterpart.
- The W-98 and W-36 pullets reached metabolic peak at 10 and 14 days after hatching, respectively.
- Moisture evaporation from feces increased *room* LHP by 8-38% (averaging 14%) during the light period and by 21-79% (averaging 43%) during the dark period. The corresponding reduction of *room* SHP was 4-17% (averaging 11%) during the light period and 14-33% (averaging 22%) during the dark period.
- HP during darkness was significantly reduced, to various degrees, as compared to that during light period. For instance, reduction for THP from light to darkness ranged from 23 to 34%.
- Diurnal *bird* or *room* LHP as percentage of THP ranged from 17 to 87% (averaging 47%) or 33 to 99% (averaging 62%), respectively, with corresponding RQ of 0.77 to 1.18 (averaging 0.92) for pullets. The corresponding values for laying hens ranged from 29 to 50% (averaging 39%) or 29 to 55% (averaging 45%) with RQ of 0.68 to 1.02 (averaging 0.90).
- Regression models relating HP and body mass (M) of the birds were developed.

## **ACKNOWLEDGEMENTS**

Funding for this study was provided by the American Society of Heating, Refrigerating and Air-conditioning Engineers (ASHRAE), and is acknowledged with gratitude. The authors wish to express appreciation to Dr. Theodore Bailey, Professor of Statistics Department, Iowa State University, for his contribution to statistical analysis of the data. The generosity of Hy-Line International in providing day-old chicks (W-36 and W-98) for the study is also sincerely appreciated. The generosity is further extended to Farmegg Products Company of Humboldt, Iowa, for providing feed for the entire study and constant assistance in procuring the growing pullets and laying hens.

## **REFERENCES**

- ASHRAE Handbook. Fundamentals. 2001. American Society of Heating, Refrigerating and Air Conditioning Engineers, Inc., Atlanta, GA.
- Boshouwers, F. M. G. and Nicaise E. 1985. Automatic gravimetric calorimeter with simultaneous recording of physical activity for poultry. *British Poultry Science* 26(4):531-541.
- Brody, S. 1945. Bioenergetics and growth. Reinhold Publishing Corporation, New York, USA.
- Chepete, H. J. and Xin. H. 2002. Heat and moisture production of poultry and their housing systems: *Literature review. Transactions of the ASHRAE* (In press).
- CIGR Handbook of Agricultural Engineering. 1999. Animal Production & Aquacultural Engineering, Vol. 2. ASAE.
- Feddes, J. J. R., McQuitty J. B., and Clark P. C. 1985. Laying hen and moisture production under commercial conditions. *Canadian Agricultural Engineering* 27(1):21-29.

- Gates, R. S., Overhults D. G., and Zhang S. H. 1996. Minimum ventilation for modern broiler facilities. *Transactions of the ASAE* 39(3):1135-1144.
- Han, T., and Xin H. 2000. Effects if intermittent lighting on breeder chicks provided with “in transit” nutrients. *Transactions of the ASAE* 43(6):1767-1770.
- Havenstein, G. B., Scheidelar S. E., Ferket P. R., Qureshi M. A., Christensen V., and Donaldson W. E. 1991. A comparison of the 1957 Athens/Canadian random bred control strain with the 1991 Arbor Acres broiler when fed diets typical of those fed in 1957 and 1991. *In Proc. North Carolina State Poultry Supervisors’ Short Course*, 1 April 1992.
- Hy-Line W-36 Commercial Management Guide. 2000-2001. Hy-Line International, Dallas Center, Iowa, USA.
- Ketelaars, E. H., Arets A., van der Hel W., Wilbrink A. J., and Verstegen M. W. A. 1985. Effect of housing system on the energy balance of laying hens. *Netherlands Journal of Agricultural Science* 33(1985):35-43.
- Li, Y., T. Ito, and S. Yamamoto. 1991. Diurnal variation in heat production related to some physical activities in laying hens. *British Poultry Science* 32(4): 821-827.
- Longhouse, A.D., Ota, H. and Ashby, W. 1960. Heat and moisture design data for poultry housing. *Agricultural Engineering* 41(9): 567-576.
- MacLeod, M. G., and Jewitt T. R. 1984. Circadian variation in the heat production rate of the domestic fowl, *gallus domesticus*: effects of limiting feeding to a single daily meal. *Comparative Biochemistry and Physiology* 78A (4):687-690.
- May, J. D. and B. D. Lott. 1994. Effects of light and temperature on anticipatory feeding by broilers. *Poultry Science* 73(9): 1398-1403.



- Ota, H. and Garver H. L. 1953. Heat and moisture production of laying hens. *Agricultural Engineering* 34(3): 163-167.
- Ota, H. and Garver H. L. 1958. Heat and moisture data from growing birds on litter and single comb caged White Leghorn layers. ASAE Paper 58-203, ASAE, St. Joseph, Mich. 49085.
- Ota, H. and McNally E. H. 1961. Poultry respiration calorimetric studies of laying hens...Single Comb White Leghorns, Rhode Island Reds, and New Hampshire × Cornish Cross. Agricultural Research Service. U.S. Department of Agriculture.
- Ouwerkerk, E. N. J. van, and Pedersen S. 1994. Application of the carbon dioxide mass balance method to evaluate ventilation rates in livestock buildings. *In Proc. XII CIGR World Congress on Agricultural Engineering*. August 29-September 1, Milano, Italy. Vol. 1: 516-529.
- Puma, M. C., H. Xin, R. S. Gates. 2001. Effects of drinking water temperature on laying hens subjected to warm cyclic environments. *Poultry Science* (In press).
- Reece, F. N. and Lott B. D. 1982a. Heat and moisture production of broiler chickens during brooding. *Poultry Science* 61(3):661-666.
- Reece, F. N. and Lott B. D. 1982b. The effect of environmental temperature on sensible and latent heat production of broiler chickens. *Poultry Science* 61(8):1590-1593.
- Riskowski, G. L., DeShazer J. A. and Mather F. B. 1977. Heat losses of White Leghorn laying hens as affected by intermittent lighting schedules. *Transactions of the ASAE* 20(4):727-731.

Xin, H., Chepete H. J., Shao J., and Sell J. L. 1998. Heat and moisture production and minimum ventilation requirements of Tom turkeys during brooding-growing period.

*Transactions of the ASAE* 41(5):1489-1498.

Xin, H., Berry I. L and Tabler G. T. 1993. Feeding and drinking patterns of broilers subjected to different feeding and lighting programs. *Applied Poultry Research* 2(4):365-372.

Xin, H., Sell J. L. and Ahn D. U. 1996. Effects of light and darkness on heat and moisture production of broilers. *Transactions of the ASAE* 39(6):2255-2258.

Zulovich, J. M., Manbeck H. B. and Roush W. B. 1987. Whole-house heat and moisture production of young floor brooded layer pullets. *Transactions of the ASAE* 30(2):455-458.

**Table 1**  
**Dietary ingredients (% , unless otherwise noted) of feed used in the study**

Dietary content	W-36 & W-98 pullets (0-35d)		W-36 birds			
	Prestarter ration	Starter ration	10wk	21wk	37wk	64wk
ME (MJ/kg)	12.20	12.20	12.70	11.80	11.60	12.20
Crude protein	21.00	20.20	16.50	18.00	14.82	15.80
Crude fat	3.10	3.30	3.60	N/A	2.77	N/A
Crude fiber	3.50	4.10	3.80	N/A	2.37	N/A
Calcium	1.04	1.04	1.04	4.25	4.42	4.12
Total phosphorus	0.75	0.65	0.66	0.76	0.47	N/A
Available phosphorus	0.52	0.43	0.47	0.57	N/A	0.31
Sodium	0.18	0.18	0.16	0.21	0.21	0.18
Total lysine	1.19	1.11	0.83	N/A	0.80	N/A
Lysine	N/A	N/A	N/A	1.03	N/A	0.82
Methionine	N/A	N/A	N/A	0.51	N/A	0.36
Total methionine	0.50	0.48	0.39	N/A	N/A	N/A
Methionine & Cystine	0.86	0.82	0.69	N/A	0.61	N/A
Choline (mg/lb)	N/A	N/A	N/A	N/A	N/A	518.50

N/A = Information not available

**Table 2a**  
**Heat production rates and respiratory quotient (RQ) of birds and housing room for W-36 pullets and layers fed ad-lib and watered from nipple drinkers during daily light, dark and time-weighted average (TWA) periods.**

Age (d or wk)	M (kg)	T <sub>a</sub> (°C)	LHP (W/kg)						SHP (W/kg)						THP (W/kg)			RQ (CO <sub>2</sub> /O <sub>2</sub> )		
			Light		Dark		TWA		Light		Dark		TWA		Light	Dark	TWA	Light	Dark	TWA
			Bird	Room	Bird	Room	Bird	Room	Bird	Room	Bird	Room	Bird	Room	Bird	Room				
1d	0.04	32.2	5.8	5.9	*	*	5.8	5.9	1.6	1.5	*	*	1.6	1.5	7.3	*	7.3	1.01	*	1.01
2d	0.04	32.2	6.1	6.8	*	*	6.1	6.8	4.6	3.9	*	*	4.6	3.9	10.7	*	10.7	1.00	*	1.00
4d	0.06	31.1	8.2	10.0	5.5	7.2	7.2	8.9	6.0	4.2	5.2	3.5	5.7	4.0	14.2	10.7	12.9	0.95	0.96	0.95
6d	0.06	31.1	10.3	11.1	5.3	7.7	8.4	9.8	5.9	5.1	6.2	3.9	6.0	4.6	16.2	11.5	14.4	1.03	0.97	1.01
8d	0.07	30.0	8.4	10.6	5.0	8.0	6.9	9.5	8.7	6.6	6.2	3.2	8.3	5.8	17.2	11.2	15.2	1.05	0.96	1.02
10d	0.07	28.9	7.8	9.7	4.1	7.2	6.4	8.8	9.6	7.7	7.3	4.2	8.8	6.4	17.4	11.4	15.2	1.00	0.97	0.96
14d	0.09	27.8	8.5	9.2	4.9	6.5	7.0	8.1	9.2	8.4	7.4	5.7	8.4	7.4	17.6	12.2	15.4	0.96	0.91	0.94
21d	0.18	25.6	6.9	8.1	5.1	6.8	6.0	7.4	9.9	8.7	6.3	4.6	8.1	6.6	16.7	11.4	14.1	0.95	0.90	0.93
28d	0.27	22.8	5.1	6.7	2.9	5.2	4.0	6.0	9.8	8.1	6.9	4.6	8.3	6.4	14.9	9.8	12.3	0.97	0.89	0.93
35d	0.35	21.1	4.7	5.7	2.8	4.1	3.7	4.9	7.7	6.7	5.6	4.3	6.6	5.5	12.4	8.4	10.4	0.99	0.99	0.99
10wk	0.81	21.1	2.4	3.3	1.7	2.5	2.1	2.9	7.0	6.2	4.7	3.9	5.9	5.1	9.4	6.4	7.9	0.97	0.90	0.94
21wk	1.40	24.4	2.8	3.0	1.9	2.3	2.4	2.7	4.6	4.4	3.7	3.2	4.2	3.9	7.4	5.6	6.5	0.85	0.90	0.88
37wk	1.48	24.4	3.2	3.6	2.1	2.8	2.8	3.3	4.6	4.1	3.4	2.7	4.2	3.7	7.8	5.5	7.0	0.95	0.99	0.96
64wk	1.53	24.4	3.0	3.3	1.9	2.8	2.8	3.1	4.4	4.0	3.7	2.7	4.0	3.6	7.3	5.6	6.7	0.87	0.89	0.88

**Table 2b**

**Heat production rates and respiratory quotient (RQ) of birds and housing room for W-98 pullets fed ad-lib and watered from nipple drinkers during daily light, dark and time-weighted average (TWA) periods.**

Age (d or wk)	M (kg)	T <sub>a</sub> (°C)	LHP (W/kg)						SHP (W/kg)						THP (W/kg)			RQ (CO <sub>2</sub> /O <sub>2</sub> )		
			Light		Dark		TWA		Light		Dark		TWA		Light	Dark	TWA	Light	Dark	TWA
			Bird	Room	Bird	Room	Bird	Room	Bird	Room	Bird	Room	Bird	Room						
1d	0.03	32.2	8.6	12.9	*	*	8.6	12.9	1.8	-2.4	*	*	1.8	-2.4	10.4	*	10.4	0.93	*	0.93
2d	0.04	32.2	9.0	11.2	*	*	9.0	11.2	3.6	1.5	*	*	3.6	1.5	12.6	*	12.6	0.93	*	0.93
4d	0.06	31.1	13.7	15.1	7.1	11.1	11.2	13.6	4.7	3.3	6.0	2.0	5.2	2.8	18.4	13.1	16.4	0.94	0.9	0.93
6d	0.06	31.1	14.4	15.3	8.2	11.7	12.1	14.0	4.7	3.8	6.4	2.8	5.3	3.4	19.1	14.5	17.4	0.91	0.89	0.90
8d	0.07	30.0	12.7	14.0	6.7	10.4	10.5	12.7	6.2	4.9	8.1	4.4	6.9	4.7	18.9	14.8	17.4	0.87	0.9	0.88
10d	0.07	28.9	10.7	12.0	6.4	9.1	9.1	10.9	8.7	7.4	8.9	6.2	8.7	6.9	19.4	15.3	17.8	0.90	0.91	0.91
14d	0.09	27.8	8.7	9.4	5.5	7.5	7.4	8.6	8.9	8.1	7.6	5.6	8.3	7.1	17.5	13.1	15.7	0.95	1.0	0.95
21d	0.17	25.6	7.1	8.7	3.6	5.8	5.4	7.3	10.9	9.3	7.9	5.7	9.4	7.5	18.0	11.5	14.8	0.95	0.91	0.93
28d	0.25	22.8	6.0	7.1	3.2	4.9	4.6	6.0	9.4	8.3	7.4	5.6	8.4	7.0	15.4	10.6	13.0	0.98	0.9	0.93
35d	0.33	21.1	4.9	5.5	2.5	3.9	3.7	4.7	9.8	9.2	7.3	5.9	8.5	7.6	14.7	9.8	12.2	0.98	0.92	0.95

M = body mass, kg; T<sub>a</sub> = ambient temperature, °C; LHP = Latent Heat Production; SHP = Sensible Heat Production; THP = Total Heat Production;

THP = LHP bird + SHP bird = LHP room + SHP room; LHP bird or SHP bird = values obtained in chambers where oil was used to submerge feces.

LHP room or SHP room = values obtained in chambers where oil was not used to submerge feces.

\* = Birds subjected to continuous lighting during the first 2 days

The number of birds per trial was 720 (2-10d), 540 (14-21d), 360 (28-35d), 324 (10 wk), or 252 (21-64 wk).

Relative Humidity ranged from 35% to 50%

Duration of trials was 5 wk continuously for 2-35d old pullets or 7d continuously for 10-64 wk old birds.

Table 3

Time weighted average regression models of total heat production rate (THP, W/kg or W/bird) vs. body mass (M, kg) for W-98 and W-36 birds expressed as THP (W/kg) =  $aM^b$  or THP (W/bird) =  $aM^c$  (where  $c = 1 + b$ )

Variable	W-98		W-36	
	3-10 d (0.04-0.07 kg, $R^2 = 0.25$ )		3-14 d (0.04-0.09 kg, $R^2 = 0.59$ )	
		S.E.		S.E.
a	26.98	4.07	27.86	2.43
b	0.16	0.05	0.25	0.03
c	1.16		1.25	
	10-35 d (0.07-0.33 kg, $R^2 = 0.76$ )		14-448 d (0.09-1.53 kg, $R^2 = 0.95$ )	
		S.E.		S.E.
a	9.34	0.24	7.64	0.07
b	-0.24	0.01	-0.35	0.01
c	0.76		0.65	

S.E = Standard error

Table 4

Time-weighted average regression models of latent heat production rate (LHP, W/kg) vs. body mass (M, kg) for W-98 and W-36 birds expressed as  $LHP = aM^2 + bM + c$

Variable	W-98 pullet				W-36 pullet and layers			
	bird LHP		room LHP		bird LHP		room LHP	
	10-35 d (0.07-0.33 kg)				14-448 d (0.09-1.53 kg)			
	$R^2 = 0.91$		$R^2 = 0.88$		$R^2 = 0.88$		$R^2 = 0.93$	
		S.E.		S.E.		S.E.		S.E.
a	79.28	12.41	47.93	15.09	5.88	0.37	5.73	0.33
b	-50.85	5.16	-39.54	6.34	-11.85	0.63	-12.34	0.57
c	12.05	0.48	12.77	0.60	7.42	0.17	8.88	0.16

S.E = Standard error

Table 5

Time-weighted average regression models of sensible heat production rate (SHP, W/kg) vs. body mass ( $M$ , kg) for *W-98* and *W-36* birds expressed as  $SHP = aM^2 + bM + c$

Variable	W-98 pullet				W-36 pullet and layers			
	<i>bird</i> SHP		<i>room</i> SHP		<i>bird</i> SHP		<i>room</i> SHP	
	3-10 d (0.04-0.07 kg)				3-14 d (0.04-0.09 kg)			
	$R^2 = 0.58$		$R^2 = 0.88$		$R^2 = 0.56$		$R^2 = 0.85$	
	S.E.		S.E.		S.E.		S.E.	
a	-1209.26	2105.65	-1773.13	1200.68	-1235.98	594.93	-922.45	425.08
b	245.20	260.44	351.46	150.58	239.59	93.77	203.00	65.51
c	-4.54	7.80	-9.89	4.56	-3.14	3.43	-4.13	2.33
	10-35 d (0.07-0.33 kg)				14-448 d (0.09-1.53 kg)			
	$R^2 = 0.37$		$R^2 = 0.02$		$R^2 = 0.91$		$R^2 = 0.80$	
	S.E.		S.E.		S.E.		S.E.	
a	-64.63	16.24	-13.06	17.3				
b	30.4	6.85	4.94	7.37	-3.57	0.11	-2.43	0.13
c	4.94	0.65	6.95	0.71	9.17	0.12	7.31	0.13

S.E. = standard error

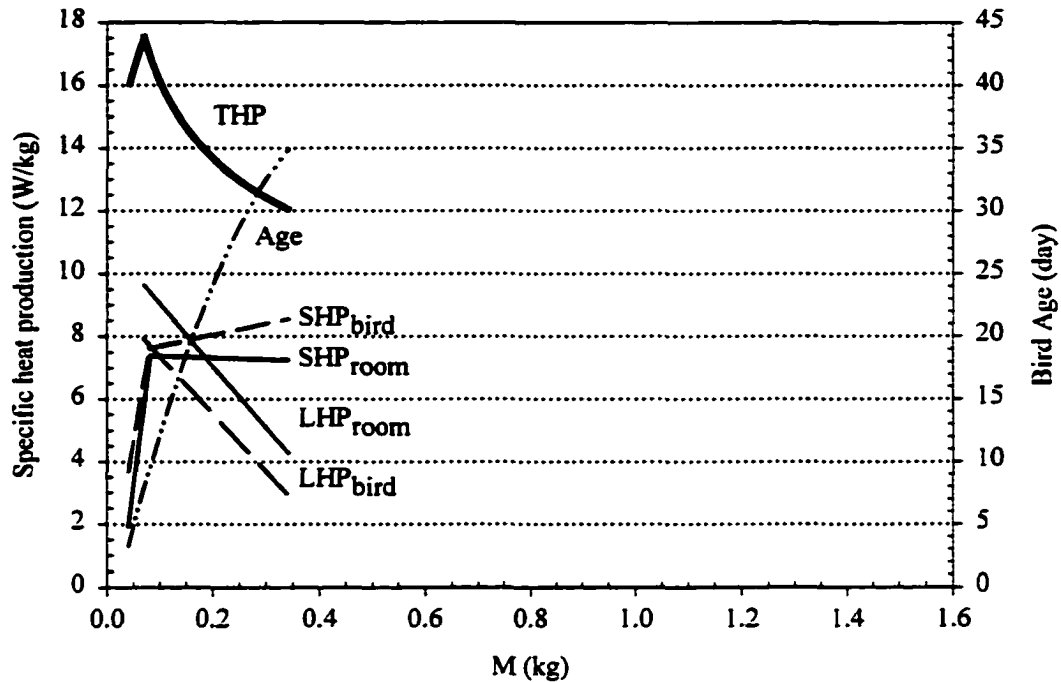


FIGURE 1. Specific heat production rate for 3- to 35-d old *W-38* pullet at thermoneutrality (21-32°C) as a function of body mass (*M*) based on time-weighted average (TWA) best-fit regression models of the measured data in the current study.

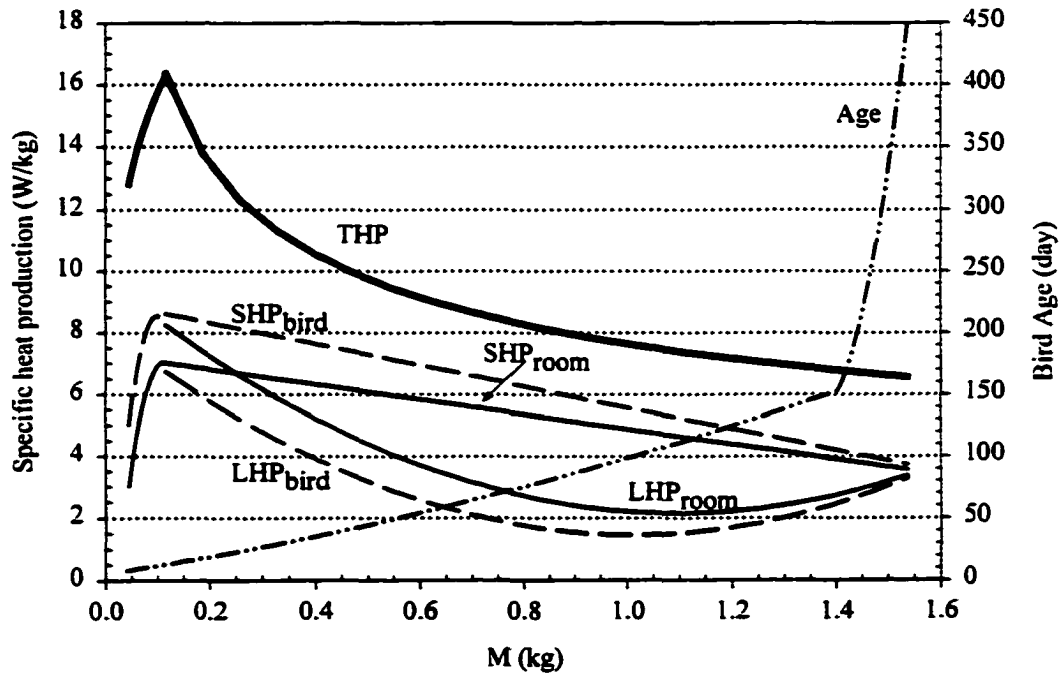
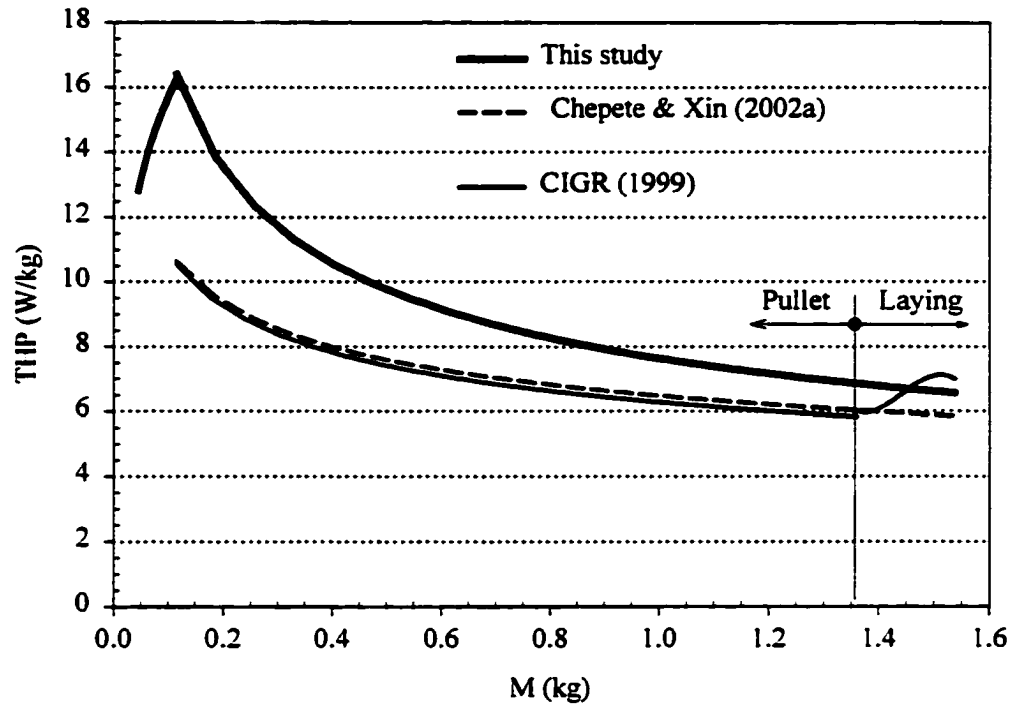
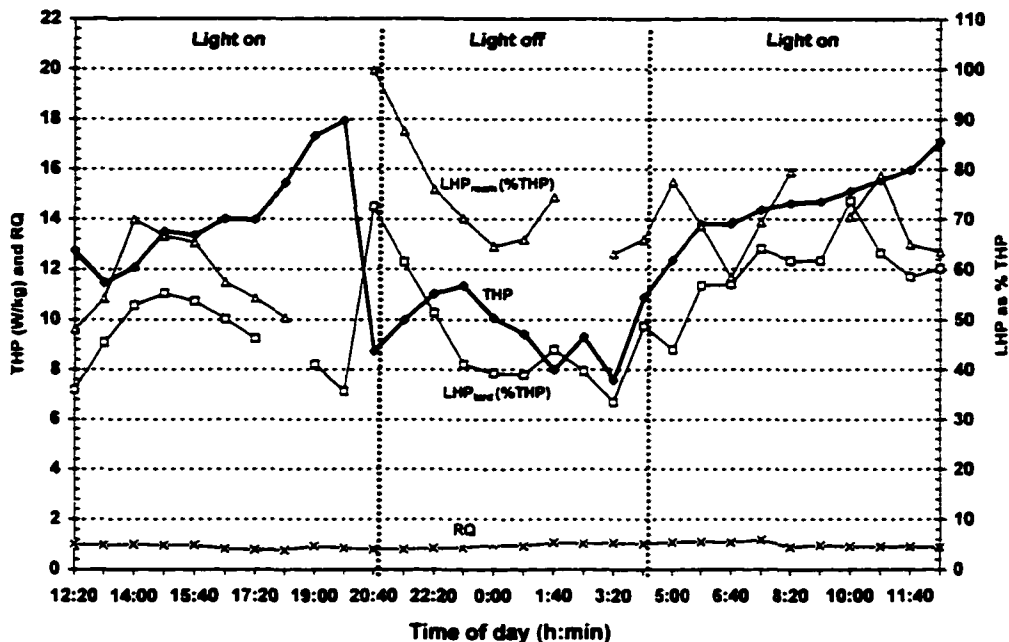


FIGURE 2. Specific heat production rate for 3- to 448-d old *W-36* pullet and laying hens at thermoneutrality (21-32°C) as a function of body mass (*M*) based on time-weighted average (TWA) best-fit regression models of the measured data in the current study.

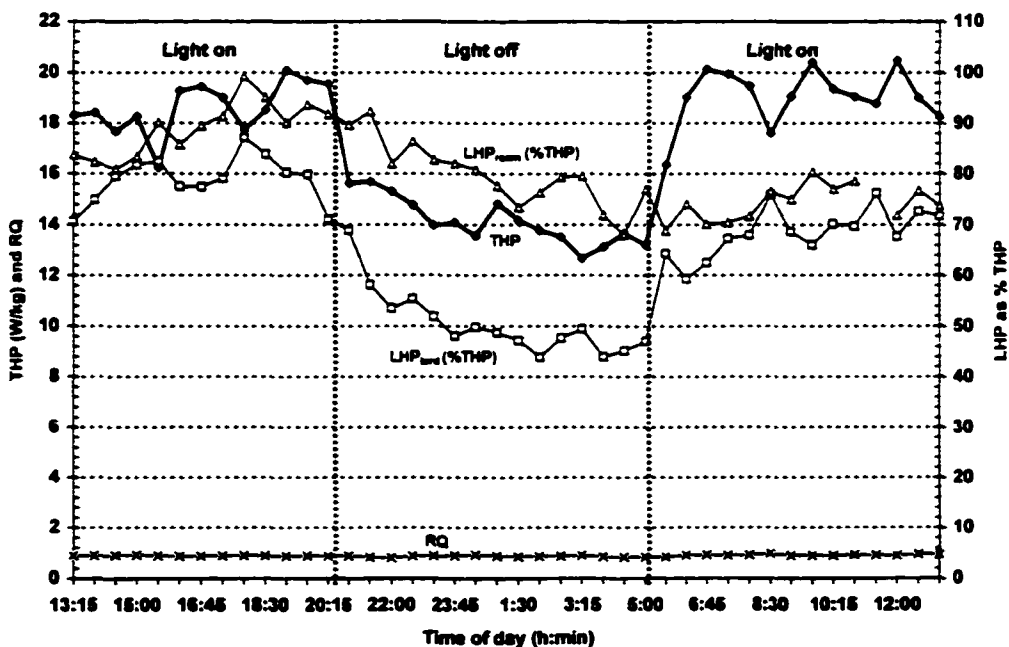




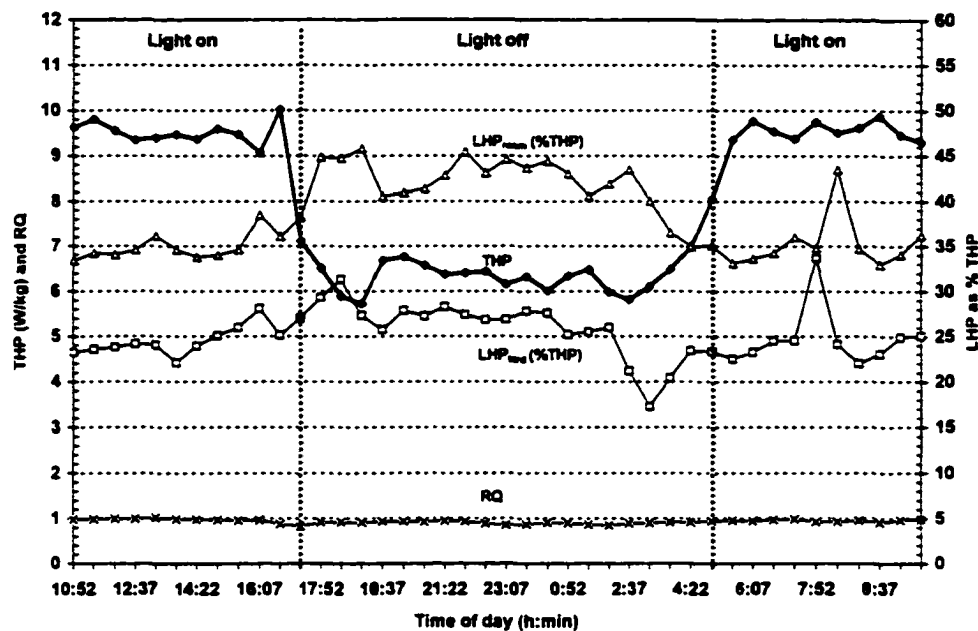
**FIGURE 3.** Comparison of total heat production rate (THP) best-fit regression models of pullet and laying hens at thermoneutrality (21-32°C) as a function of body mass (M).



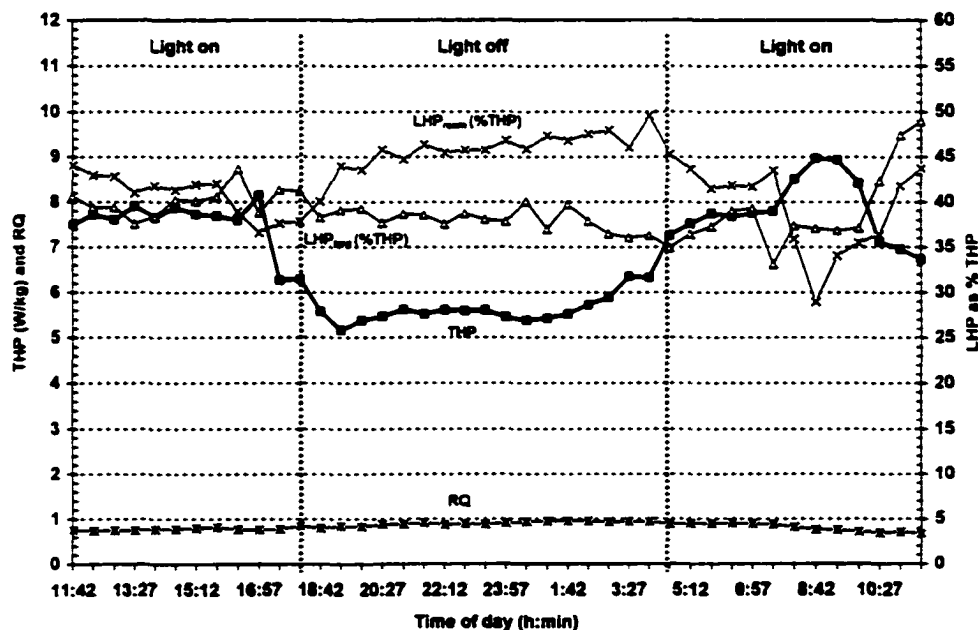
**Figure 4.** Diurnal profiles of total heat production rate (THP), respiratory quotient (RQ), and latent heat production rate (LHP) as % THP for ad-lib fed 4-day-old *W-36* pullets under 31°C temperature. Birds had water from nipple drinkers. THP and RQ were averaged over four chambers while  $LHP_{\text{bird}}$  and  $LHP_{\text{room}}$  were each averaged over two chambers.



**Figure 5.** Diurnal profiles of total heat production rate (THP), respiratory quotient (RQ), and latent heat production (LHP) as % THP for ad-lib fed 4-day-old *W-98* pullets under 31°C temperature. Birds had water from nipple drinkers. THP and RQ were averaged over four chambers while  $LHP_{\text{bird}}$  and  $LHP_{\text{room}}$  were each averaged over two chambers.



**Figure 6.** Diurnal profiles of total heat production rate (THP), respiratory quotient (RQ), and latent heat production (LHP) as % THP for ad-lib fed 10-week-old *W-36* pullets under 21°C temperature. Birds had water from nipple drinkers. THP and RQ were averaged over four chambers while  $LHP_{bird}$  and  $LHP_{room}$  were each averaged over two chambers.



**Figure 7.** Diurnal profiles of total heat production rate (THP), respiratory quotient (RQ), and latent heat production (LHP) as % THP for ad-lib fed 21-week-old *W-36* layers under 24°C temperature. Birds had water from nipple drinkers. THP and RQ were averaged over four chambers while  $LHP_{bird}$  and  $LHP_{room}$  were each averaged over two chambers.

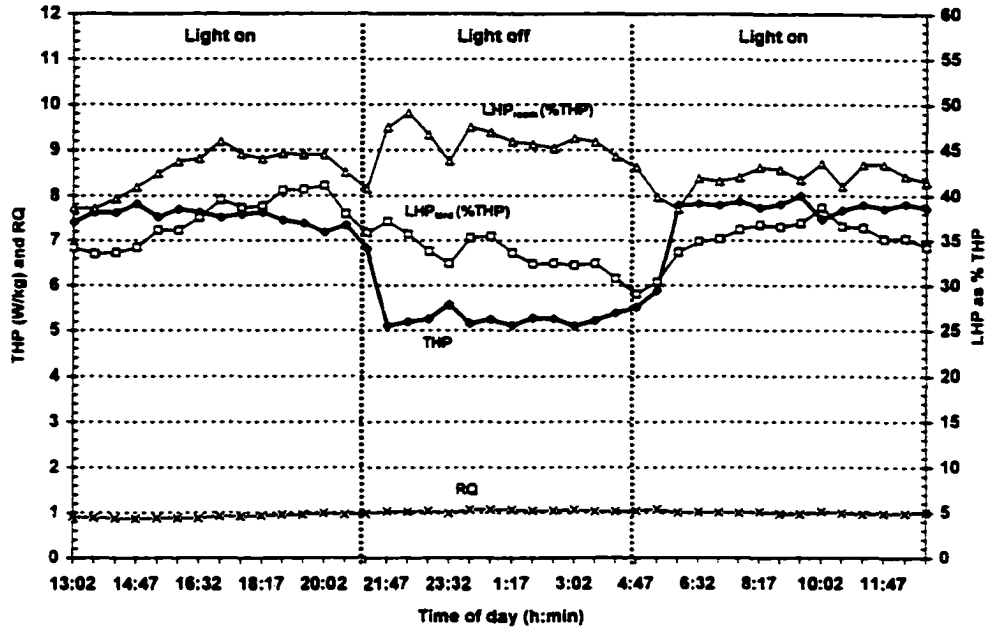


Figure 8. Diurnal profiles of total heat production rate (THP), respiratory quotient (RQ), and latent heat production (LHP) as % THP for ad-lib fed 37-week-old *W-36* layers under 24°C temperature. Birds had water from nipple drinkers. THP and RQ were averaged over four chambers while  $LHP_{bird}$  and  $LHP_{room}$  were each averaged over two chambers.

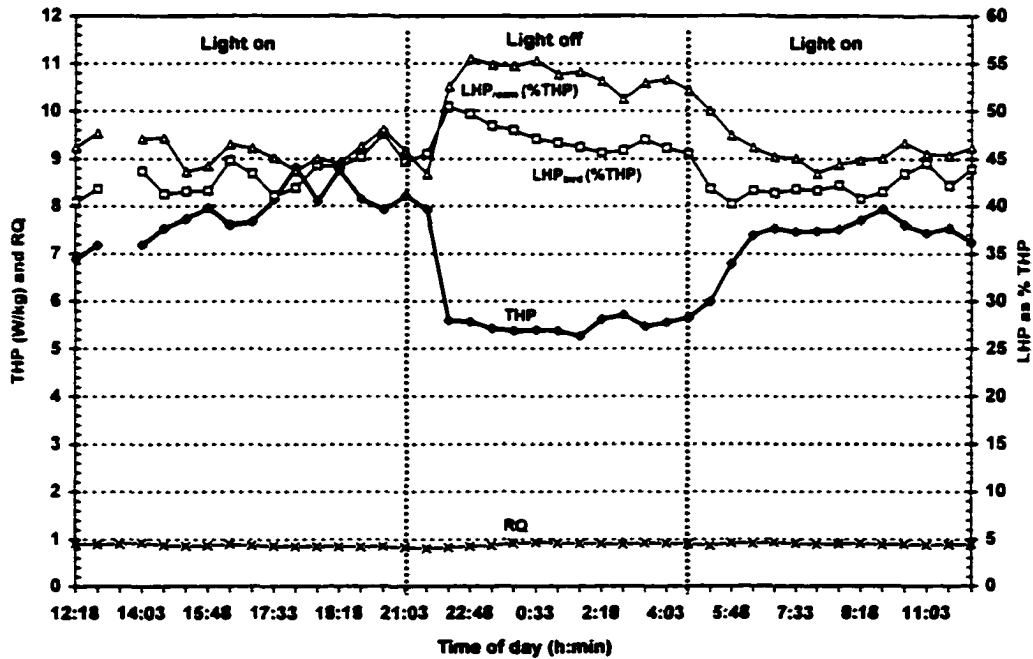


Figure 9. Diurnal profiles of total heat production rate (THP), respiratory quotient (RQ), and latent heat production (LHP) as % THP for ad-lib fed 64-week-old *W-36* layers under 24°C temperature. Birds had water from nipple drinkers. THP and RQ were averaged over four chambers while  $LHP_{bird}$  and  $LHP_{room}$  were each averaged over two chambers.

**CHAPTER 4.****HEAT AND MOISTURE PRODUCTION OF POULTRY AND THEIR  
HOUSING SYSTEMS: *MOLTING LAYERS***

A paper submitted to the Transactions of the American Society of Heating Refrigerating and  
Air-conditioning Engineers (ASHRAE)

H. J. Chepete and H. Xin

**ABSTRACT**

Heat and moisture production rates (HP, MP) of modern 68- to 75-week old Hy-Line W-36 laying hens during the molting stage were measured using large-scale indirect calorimeters that mimic commercial production settings. The HP and MP were measured continuously during acclimation, fasting, restricted feeding, and post molt periods. Total HP (THP) was partitioned into latent and sensible HP (LHP, SHP) which incorporated the influence of fecal moisture evaporation. THP ranged from 4.4 to 5.6 W/kg, 5.4 to 6.5 W/kg, and 6.7 to 6.9 W/kg during fasting, restricted feeding and post molt periods, respectively. LHP ranged from 1.7 to 2.1 W/kg, 1.5 to 2.0 W/kg, and 2.4 to 2.9 W/kg during the respective periods. The corresponding SHP ranged from 2.6 to 3.5 W/kg, 3.9 to 4.6 W/kg, and 3.9 to 4.4 W/kg, respectively. The corresponding respiratory quotient (RQ) averaged 0.71, 0.76, and 0.92, respectively. HP values during the light period were significantly higher ( $P < 0.05$ ) than that during the dark period. LHP as a percentage of THP ranged from 24 to 43% with no significant differences between the light and dark periods. Results of this study provide a

new thermal load database for design of building ventilation systems for laying hens undergoing molting phase.

**KEYWORDS:** Thermal load, Ventilation, Bioenergetics

## **INTRODUCTION**

Molting is a natural process of all birds in an endeavor to renew their feathers (Lucas and Stettenheim, 1972; North, 1984) prior to migration, shorter days, or cooler weather (North, 1984); and is regulated by hormones (Whittow, 1976; Perek et al., 1957; Blivaiss, 1947b; Van der Meulen, 1939). Normally, wild chickens molt once a year and the molt is not associated with the laying cycle (North, 1984). Domestic chickens are bred for high egg production and go into molting after a long and intensive laying period. In order to give them rest, molting is often induced, particularly at or near the time when they naturally molt (Sturkie, 1954; Van der Meulen, 1939). This is achieved through several means like feed withdrawal (Noles, 1966; North, 1984, Witham, 2001), drugs and chemicals (North, 1984; Scott and Creger, 1976; Whitehead and Shannon, 1974; Adams, 1955; Sturkie, 1954; Van der Meulen, 1939), and light reduction (North, 1984; Jensen, 1980). The methods that are widely adopted are those that create least amount of stress, produce a rapid molt, and get birds back to egg production quickly.

The thyrotrophic and thyroid hormones have been reported to promote molting (Whittow, 1976; Blivaiss, 1947b; Van der Meulen (1939), impair egg laying (Zawadowsky and Nesmeyanova, 1937), and increase metabolic activity (Whittow, 1976). Loss of feathers, naturally or artificially, causes an increase in heat production and heat loss (Perek and Sulman, 1945; Hoffman and Shaffner, 1950).

Economic circumstances, such as anticipation of high egg prices or lack of available cash due to depressed egg prices, often drive decisions to put hens into a molt (North, 1984; Bell and Swanson, 1974). The merits of molting laying hens include increased egg production (up to 85-90% of the first year production), larger egg size, and improved eggshell quality (North, 1984, Witham, 2001). However, these levels would be somewhat lower than their best pre-molt values (Hy-Line W-36 Commercial Management Guide, 2000-2001).

In view of the above-mentioned physiological implications on molted birds, there is need to provide them with optimum environment through adequate ventilation. Building ventilation rate designs are based on the heat and moisture production rates (HP and MP) of the housed animals. Data of HP and MP of non-molting laying hens have recently been updated (Chepete and Xin, 2002b) and that of molting hens was not found in the literature search (Chepete and Xin, 2002a). This suggests that ventilation rates for molting hens are designed presumably using data of non-molting ones. In order to provide molting hens with optimum ventilation rates, specific HP and MP data on this situation are needed. The objective of this study was to measure HP and MP of W-36 laying hens during the molting conditions that follow the current commercial production practices.

## **MATERIAL AND METHODS**

### **Experimental Birds and Facility**

The Iowa State University (ISU) indirect calorimeter system, consisting of four calorimeter chambers as described by Xin et al. (1998), was used for this study. The gas (O<sub>2</sub> and CO<sub>2</sub>) analyzers were calibrated twice daily throughout the measurement period (7 weeks continuous) to ensure measurement accuracy of  $\pm 0.5$  Watt per chamber (>65 Watt output).

In all trials performed, metal pans were placed under each cage compartment to collect the feces and thus the MP included that from both the birds and their housing components (i.e., litter and fecal matter). The latent and sensible heat production rates (LHP or SHP) measured were thus *room* values. The commercial management practices (feeding, photoperiod, temperature, stocking density, and manure handling) were followed throughout the trial, as described below. Specifically, manure was removed from all chambers twice weekly. Birds were group-weighted weekly throughout the trial.

### **HP and MP Measurements**

A flock of 252 hens at 68 weeks of age and averaging 1.7 kg was procured from a commercial farm in Iowa and delivered to the ISU Livestock Environment and Animal Physiology (LEAP) Laboratory in Ames. Upon arrival, the birds were group-weighted and randomly allocated to the four indirect calorimeter chambers with 63 birds per chamber (or 7 hens per cage). These bird numbers ensured sufficient changes in air composition ( $O_2$  and  $CO_2$ ) for the instruments to make accurate measurements. Each chamber had a movable supporting stand with nine cages (55 cm L  $\times$  50 cm W  $\times$  41H cm each).

The birds were acclimated for a week. During this period, birds were fed *ad libitum* (Table 1). The lighting schedule was 16hL:8hD and the initial temperature set point was 26.7 °C which was then reduced by 1 °C daily until it reached 20 °C. At the beginning of the second week, feed was withdrawn, temperature was kept at 20 °C, and lighting schedule changed to 9hL:15hD. The objective of feed withdrawal was to induce molting and reduce the bird body mass (M) to an equivalent of 20-week old pullet of the same breed (1.22 to 1.27 kg/bird). The birds were expected to stop laying eggs at this M range. To monitor the bird M, a group of 18 birds was randomly sampled from each calorimeter every two days and



weighed. When the aforementioned M range was reached, birds were put on restricted feeding with pullet ration (Table 1) for two weeks at an average of 5.2 kg/(100-day) to provide maintenance energy while maintaining their M strictly between 1.22 to 1.27 kg. If M increased, a day was skipped without providing feed to the birds. After the restricted feeding period, the temperature was raised to 24.4 °C, lighting increased to 13hL:11hD and birds were fed layer ration (Table 1) *ad libitum* for three weeks during which they were expected to increase M and resume laying. Throughout the experimental period, the birds had free access to water through nipple drinkers. Relative humidity (RH) ranged from 37 to 45%. Light intensity was maintained at 5 to 11 lux. The experimental protocols complied with the guidelines on the care and use of animals for research by the institutional committee.

### **Data Analysis and Presentation**

For each 24-h period of the trial, the data were separated into dark and light periods and their time-weighted averages (TWA) determined. The data were subjected to analysis of variance (ANOVA) using Statistical Analysis Software (SAS) (SAS Institute, Inc. 1999-2000). The measured parameters were presented graphically as functions of bird age and in a summary table of their mean values. Data collected during cleaning of the calorimeters and weighing of the birds were excluded from the analysis.

### **RESULTS AND DISCUSSION**

Figure 1 shows the changes in plumage of the birds during fasting through post molt period. Egg production and bird mass (M) are both depicted in figures 2 through 4. Total heat production (THP), LHP, SHP and respiratory quotient (RQ, CO<sub>2</sub>/O<sub>2</sub>) of the *room* (LHP and SHP) under light, dark and TWA conditions are summarized in Table 2 as 2- to 4-day

averages. The HP parameters are shown in figures 2 through 4 while RQ is shown in figure 5. Latent heat production rate (LHP) as a percentage of THP is shown in figure 6.

### **Egg Production**

During the acclimation period, egg production averaged 39 g/(bird-day). Upon fasting, egg production dropped drastically and ceased by the end of fasting period. This is consistent with reports by Witham (2001) and Zawadowsky and Nesmeyanova (1937). Most of the eggs laid two days after onset of fasting broke into the metal pans presumably due to thin eggshells as the birds lacked calcium. During restricted feeding period, there were no eggs produced. Egg production resumed about 11 days after start of post molt period when birds were fed *ad libitum*.

### **Bird Mass**

Upon arrival, the birds averaged 1.7 kg which was reduced to an average of 1.2 kg/bird when fasting. During restricted feeding, the M ranged from 1.2 to 1.3 kg/bird and was within the industry recommended range in order for the birds not to lay eggs. During the post molt period, M increased to a range of 1.4 to 1.5 kg/bird.

### **Behavioral and Physical Observations**

The birds were observed to peck on different objects, a feed-seeking activity (Lundy, 1978) when fasting. During the restricted feeding period, the birds scrambled at the feed and ate vigorously and competitively the entire time. The scramble for feed was also observed during the first day of post molt period and thereafter stopped as birds continued to have access to feed *ad libitum*. During fasting period, the birds had good feather cover (fig. 1a). The birds then shed a lot of their feathers during the first week of restricted feeding period

(fig. 1b) and this was consistent with reports by Lucas and Stettenheim (1972) and North (1984). The feathers rejuvenated during the post molt period (fig. 1c).

## **THP**

The relationship between THP and bird age is shown in figure 2. There were significant differences ( $P < 0.05$ ) in THP between acclimation, fasting, restricted feeding and post molt periods for both light and dark periods. THP was significantly reduced by 19 to 37% upon switching from light to dark. Chepete and Xin (2002b) stated 23 to 35% reduction on non-molting 3-d to 64-week old W36 birds under thermoneutral (TN) conditions.

During acclimation period, the average THP ranged from 6.2 to 6.8 W/kg. Chepete and Xin (2002b) reported 6.7 W/kg for 1.53 kg (64 weeks of age) layers at 24.4°C. When fasting, the average THP was reduced to a range of 4.4 to 5.6 W/kg, a 21 to 41% reduction as compared with THP during acclimation. O'neill and Jackson (1974) reported 4.9 and 4.7 W/kg on fasted white leghorn hybrid H & N cockerels at 62 (1.63 kg) and 78 (1.69 kg) weeks of age, respectively and 23 °C air temperature. According to Brody (1945), the heat produced by animals is a result of oxidation of carbohydrates during respiration. During fasting, carbohydrates were expected to be insufficient in the birds' bloodstream which would reduce the metabolic rate and consequently lower the total heat output. Comparatively, THP was significantly higher during the first two days of fasting (averaging 5.6 W/kg) while the latter four days had lower THP (averaging 4.5 W/kg). The higher THP during initial stage of fasting was a result of the utilization of feed that was still in the birds' digestive tract (i.e. post-absorption) and they probably began using body fat to provide energy during the latter part, which is evidenced by gradual reduction in M. Further, animals tend to conserve energy

for use in maintenance when fasted by reducing heat generating mechanisms such as cessation of lay and reduced locomotor activity (Lundy, 1978).

During the restricted feeding period, there was a sharp increase in average THP up to 6.5 W/kg during the first three days after which it gradually declined. The sharp increase in THP may be due to loss of feathers that is reported to cause an increase in HP (Perek and Sulman, 1945; Hoffman and Shaffner, 1950). Other contributing factors may include increased bird activities such as vigorous feeding (Yunianto et al., 1997) and changes in posture (Lundy, 1978). Up to 25% of the increase in THP is related to physical activity in laying hens (Boshouwers and Nicaise, 1985). Standing alone was reported to increase HP of Light Sussex cocks by 40 to 50% (Deighton and Hutchinson, 1940). The oscillations in the trend of THP were caused by days when feed was not provided while trying to keep the birds' M within the recommended range. In the latter 10 days of this period, the average THP stabilized within a range of 5.4 to 5.9 W/kg and was 13% lower or 5 to 23% higher than that during acclimation and fasting, respectively. Energy restriction decreases the metabolic rate since the latter increases with increase in metabolizable energy (Mitchell, 1962).

During the post molt period, the average THP increased slightly and stabilized at 6.7 to 6.9 W/kg. Besides activity, heat increment of feeding and the cost of egg synthesis and oviposition (van Kampen, 1976) are likely to be responsible for the nature of THP trend during this period. Under similar conditions, Chepete and Xin (2002b) reported a value of 6.7 W/kg for 1.53 kg (64- week) old hens. THP during the post molt period was 23 to 52% higher than that of fasting period. Meltzer (1987) stated a 25 to 68% higher THP in the fed than starved adult birds. Lundy et al. (1978) reported a 27 or 29% lower THP in the starved than fed Babcock or Warren birds, respectively, under 19 to 21°C temperature.

A THP range of 6.6 to 6.8 W/kg for 1.8 kg leghorn laying hen (Albright, 1990) has been widely used in ventilation design for laying hens. For molting birds, such data may result in over-ventilation during fasting and restricted feeding periods and this may have negative impact on bird welfare and production costs. The values are 21 to 50% and 5 to 22% higher than that measured in this study during fasting and restricted feeding periods, respectively.

### **LHP**

Figure 3 shows LHP as a function of bird age. There were significant differences ( $P < 0.05$ ) in LHP between acclimation, fasting, restricted feeding and post molt periods for both light and dark periods. With reference to acclimation period, LHP reduction during the light period averaged 7 or 9% during fasting or restricted feeding, respectively. The corresponding reduction during the dark period was 13 or 19%. During the post molt period, LHP was 19 or 26% higher for light or dark period, respectively, when compared to that during the acclimation period. LHP was significantly reduced by 20 to 51% upon switching from light to dark. Chepete and Xin (2002b) stated 15 to 31% reduction on non-molting 3-d to 64-week old W36 birds under TN conditions. The average LHP ranged from 2.1 to 2.4 W/kg during acclimation period. Chepete and Xin (2002b) reported 3.1 W/kg for 1.53 kg (64 weeks of age) layers at 24.4°C. When fasting, LHP steadily declined from an average high of 2.1 W/kg to a lower value of 1.7 W/kg. This decline was not as steep as was expected. Most eggs broke during this period probably due to calcium deficiency and the water contained therein may have contributed extra moisture production or LHP.

During the restricted feeding period, the average LHP increased to a peak value of 2.0 W/kg and then steadily declined to a range of 1.5 to 1.9 W/kg. For the post molt period, the

average LHP increased steadily and stabilized at 2.9 W/kg. It then staggered between 2.5 and 2.8 W/kg as the birds began to lay eggs. As with THP, this higher LHP, compared to that during fasting and restricted feeding periods, may be a result of increased bird activity and physiological factors associated with egg production. Ota and McNally (1961) measured LHP of 1.1 to 1.3 W/kg or 0.7 to 0.9 W/kg during the day or night, respectively, on 51- to 70-week old New Hampshire × Cornish cross layers kept at 18 to 24°C ambient temperature. These values are less than those measured in this study (table 2) during post molt period.

### **SHP**

The variation of SHP with bird age is shown in figure 4. There were significant differences ( $P < 0.05$ ) in SHP between acclimation, fasting, restricted feeding and post molt periods for both light and dark periods. With reference to acclimation period, SHP reduction during fasting period averaged 21 or 24% during the light or dark period, respectively. The corresponding increase in SHP during restricted feeding period averaged 3 or 13% for light or dark period, respectively. During the post molt period, SHP averaged 4% higher during the light period and 2% lower during the dark period when compared to that during the acclimation period. SHP was significantly reduced by 13 to 35% upon switching from light to dark. Chepete and Xin (2002b) stated 17 to 52% reduction on non-molting 1- to 64-week old W36 birds under TN conditions. The average SHP ranged from 3.8 to 4.6 W/kg during the acclimation period. Chepete and Xin (2002b) reported 3.6 W/kg for 1.53 kg (64 weeks of age) layers at 24.4°C. Upon fasting, SHP dropped sharply from 4.6 W/kg at end of acclimation period, to 2.6 W/kg where it remained fairly stable. This period coincides with the time when most of the eggs produced were broken. As such, part of the sensible heat was

used in the evaporation of moisture contained in the eggs, thereby increasing the latent heat and reducing the sensible heat.

During the restricted feeding period, the average SHP sharply increased in the initial three days from a low of 2.7 W/kg (at the end of fasting period) to an average high of 4.6 W/kg. This may be associated with bird activity as previously mentioned. The average SHP then gradually reduced to an average of 3.9 W/kg in the last week of this period.

During the post molt period, SHP slightly increased initially and then dropped to a steady average value of 4.0 W/kg. As birds began to produce eggs, SHP increased slightly to about 4.4 W/kg and then dropped back to an average value of 4.0 W/kg. The increase in metabolic activity associated with egg production (van Kampen, 1976) may have caused the rise in SHP. Ota and McNally (1961) measured SHP of 2.7 to 3.5 W/kg or 2.5 to 2.9 W/kg during the day or night, respectively, on birds previously mentioned.

## RQ

Figure 5 shows variation of RQ with bird age. RQ varies depending on the metabolic rate, feed intake and individual status of the animal (Ouwkerk and Pedersen, 1994). During acclimation, RQ ranged from 0.82 to 0.94 (averaging 0.88). When fasting, the RQ dropped to a range of 0.66 to 0.80 (averaging 0.71). RQ decreased probably because fat was preferentially metabolized during starvation (Koskemies, 1950). Lundy et al. (1978) reported an RQ of 0.74 and 0.96 for starved and fed birds, respectively. In the restricted feeding period, the RQ ranged from 0.65 to 0.82 (averaging 0.76). During the post molt period, the RQ ranged from 0.85 to 0.98 (averaging 0.92). Chepete and Xin (2002b) and Ketelaars et al. (1985) reported average RQ values of 0.91 for laying hens at 21- to 64-week of age and 0.92 for laying hens at normal production, respectively.

### **LHP as a Percentage of THP**

Figure 6 shows LHP as a percentage of THP. The variation between light and dark periods was not significantly different ( $P=0.65$ ). This result might be due to the proportionate partition of THP into LHP and SHP, where they both increased or decreased during the light or dark periods, respectively. The ranges were 30 to 41, 36 to 42, 24 to 36, and 34 to 43% during acclimation, fasting, restricted feeding, and post molt periods, respectively. HP data reported by Ota and McNally (1961) indicated a range of 22 to 32% for 51- to 70-week old birds kept at 19 to 24°C temperature while that derived from data by Albright (1990) resulted in a range of 35 to 43% for 1.8 kg leghorn laying hen at 18 to 28°C temperature.

### **Diurnal HP and MP Profiles**

Diurnal HP and MP or LHP profiles for the different molting stages are shown in figures 7 through 9. LHP of the *room* has been expressed as a percentage of THP and it ranged from 33 to 60%, 25 to 38%, and 36 to 49% during fasting, restricted feeding, and post molt periods, respectively. As previously mentioned, the higher LHP during fasting was due to additional moisture from the eggs that broke. When the light was on, birds became more active and this may have resulted in higher HP as compared to dark period.

### **CONCLUSIONS**

Heat and moisture production rates (HP and MP) of modern W-36 laying hens during the molting stage were measured using large-scale indirect calorimeters. Latent HP (LHP) and sensible HP (SHP) included the effect of moisture evaporation from the feces. The following conclusions were drawn.



- Total HP (THP) ranged from 4.4 to 5.6 W/kg, 5.4 to 6.5 W/kg, and 6.7 to 6.9 W/kg during fasting, restricted feeding and post molt periods, respectively.
- LHP ranged from 1.7 to 2.1 W/kg, 1.5 to 2.0 W/kg, and 2.4 to 2.9 W/kg during the respective periods.
- The corresponding SHP ranged from 2.6 to 3.5 W/kg, 3.9 to 4.6 W/kg, and 3.9 to 4.4 W/kg, respectively.
- The corresponding respiratory quotient (RQ) averaged 0.71, 0.76, and 0.92, respectively.
- HP values during the light period were significantly higher ( $P < 0.05$ ) than that during the dark period.
- The daily mean LHP as a percentage of THP ranged from 24 to 43% while the diurnal value ranged from 25 to 60%.

## **ACKNOWLEDGEMENTS**

Funding for this study was provided in part by the American Society of Heating, Refrigerating and Air-conditioning Engineers (ASHRAE) and by the Multi-State Research Project “NE-127 Biophysical Models for Poultry Production Systems”, and are acknowledged with gratitude. The authors wish to express appreciation to Nelson S. Kabomo for his contribution in providing help throughout the experiment. The generosity of Farmegg Products Company of Humboldt, Iowa, in providing feed for the entire study and assistance in procuring the laying hens, is highly appreciated.

**REFERENCES**

- Adams, J. L. 1955. Progesterone-induced unseasonal moult in single comb White Leghorn pullets. *Poultry Science* 34(3): 702-707.
- Albright, L. D. 1990. Environment control for animals and plants. ASAE. St. Joseph, MI.
- Bell, D. D. and Swanson M. H. 1974. Laying flock performance during three production cycles. *In Proc. XV World Poultry Congress, New Orleans, 537-539.*
- Blivaiss, B. B. 1947b. Development of secondary sexual characters in the thyroidectomized Brown Leghorn hen. *Journal of Experimental Zoology* 104(2):267-305.
- Boshouwers, F. M. G. and Nicaise E. 1985. Automatic gravimetric calorimeter with simultaneous recording of physical activity for poultry. *British Poultry Science*. 26(4):531-541.
- Brody, S. 1945. Bioenergetics and growth. Reinhold Publishing Corporation, New York, USA.
- Chepete, H. J. and Xin. H. 2002a. Heat and moisture production of poultry and their housing systems: *Literature review. Transactions of the ASHRAE* (In press).
- Chepete, H. J. and Xin. H. 2002b. Heat and moisture production of poultry and their housing systems: *Pullets and Layers. Transactions of the ASHRAE* (In review).
- Deighton, T. and Hutchinson J. C. D. 1940. Studies on the Metabolism of Fowls. II. The Effect of Activity on Metabolism. *Journal of Agriculture Science* 30(1):141-157.
- Hoffman, E. and Shaffner C. S. 1950. Thyroid weight and function as influenced by environmental temperature. *Poultry Science* 29(3): 365-376.
- Hy-Line W-36 Commercial Management Guide. 2000-2001. Hy-Line International, Dallas Center, Iowa, USA.

- Ketelaars, E. H., Arets A., van der Hel W., Wilbrink A. J., and Verstegen M. W. A. 1985. Effect of housing system on the energy balance of laying hens. *Netherlands Journal of Agricultural Science* 33(1985):35-43.
- Koskemies, J. 1950. The life of the swift, *Micropus apus* (L) in relation to the weather. *Annales Academiae Scientiarum Fennicae, Series A, IV, Biologica* 15:1-151.
- Lucas, A. M. and Stettenheim P. R. 1972. Avian anatomy, Integument. Part 1: 197-233. *Agriculture Handbook* 362, Washington DC.
- Lundy, H., Macleod M. G., and Jewitt T. R. 1978. An automated multi-calorimeter system: preliminary experiments on laying hens. *British Poultry Science* 19(2):173-186.
- Meltzer, A. 1987. Acclimation to ambient temperature and its nutritional consequences. *World Poultry Science Journal* 43(1):33-44.
- Mitchell, H. H. 1962. Comparative nutrition of man and domestic animals, Vol. 1. Academic Press, New York.
- Noles, R. K. 1966. Subsequent production and egg quality of forced moulted hens. *Poultry Science* 45(1): 50-57.
- North, M. O. 1984. Commercial chicken production manual. 3<sup>rd</sup> edition. AVI Publishing company, Inc. Connecticut.
- O'Neill, S. J. B. and Jackson N. 1974. The heat production of hens and cockerels maintained for an extended period of time at a constant environmental temperature of 23°C. *Journal of Agricultural Science, Cambridge* 82(2): 549-552.
- Ota, H. and McNally E. H. 1961. Poultry respiration calorimetric studies of laying hens...Single Comb White Leghorns, Rhode Island Reds, and New Hampshire × Cornish Cross. Agricultural Research Service, 42. U.S. Department of Agriculture.

- Ouwerkerk, E. N. J. van, and Pedersen S. 1994. Application of the carbon dioxide mass balance method to evaluate ventilation rates in livestock buildings. *In Proc. XII CIGR World Congress on Agricultural Engineering. August 29-September 1, Milano, Italy. Vol. 1: 516-529.*
- Perek, M, Eckstein B. and Sobel H. 1957. Histological observations on the anterior lobe of the pituitary gland in moulting and laying hens. *Poultry Science* 36(5): 954-958.
- Perek, M. and Sulman F. 1945. The basal metabolic rate in molting and laying hens. *Endocrinology*. 36(3): 240-243.
- Scott, J. T. and Creger C. R. 1976. The use of zinc as an effective moulting agent in laying hens. *Poultry Science*, 55(5):2089. Abstract.
- Sturkie, P. D. 1954. *Avian Physiology*. Comstock Publishing Associates. Ithaca. N.Y.
- Van der Meulen, J. B. 1939. Hormonal regulation of molt and ovulation. *Proc. Seventh World's Poultry Congress*. 109-112.
- Van Kampen, M. 1976. Activity and energy expenditure in laying hens. The energy cost of nesting activity and oviposition. *Journal of Agricultural Science, Cambridge* 86(3):471-473.
- Witham, S. 2001. *Personal Communication*. Humboldt, IA: Farmegg Products Company.
- Whitehead, C. C. and Shannon D. W. F. 1974. The control of egg production using a low-sodium diet. *British Poultry Science*, 15(5):429-434.
- Whittow, G. C. 1976. Energy metabolism. *In Avian Physiology*. 3<sup>rd</sup> edition. (P. D. Sturkie, ed.). Springer-Verlag New York, Inc. N.Y.

Yunianto, V. D., Hayashi K., Kanade S., Ohtsuka A., and Tomita Y. 1997. Effect of environmental temperature on muscle protein turnover and heat production in tube-fed broiler chickens. *British Journal of Nutrition* 77(6):897-909.

Zawadowsky, B. M. and E. G. Nesmeyanova. 1937. Antagonistic effect of androsteron on hyperthyroid moulting of hens. *Bulletin de Biologie et de Medecine Experimentale de l'URSS* 3(2): 119-120.

**Table 1**  
**Dietary ingredients (% , unless otherwise noted) of feed used in the study**

Dietary content	Layer ration <sup>1</sup>	Pullet ration <sup>2</sup>	Layer ration <sup>3</sup>
ME (MJ/kg)	11.86	12.54	11.95
Crude protein	14.00	16.81	16.00
Crude fat	2.90	N/A	4.50
Crude fiber	2.40	N/A	2.40
Calcium	3.85	0.94	4.25
Total phosphorus	0.50	N/A	0.64
Available phosphorus	0.50	0.37	0.45
Sodium	0.18	0.15	0.19
Lysine	0.73	0.89	0.85
Methionine	0.33	0.39	0.40
Methionine & Cystine	0.60	0.68	0.69
Tryptophan	N/A	0.20	N/A
Threonine	N/A	0.63	N/A
Protein equivalent	N/A	18.96	N/A

<sup>1</sup> = acclimation; <sup>2</sup> = restricted feeding; <sup>3</sup> = post molt

N/A = information not available

**Table 2**  
**Heat production rates and respiratory quotient (RQ) of Hy-line W-36 molting layers during daily light, dark, and time-weighted average (TWA) periods. Birds had free access to water through nipple drinkers during all phases. The latent and sensible heat production rate (LHP, SHP) included the effect of fecal moisture evaporation.**

Feed regimen	Hours	Age (d)	M (kg)	T <sub>a</sub> (°C)	RH (%)	LHP (W/kg)			SHP (W/kg)			THP (W/kg)			RQ (VCO <sub>2</sub> /VO <sub>2</sub> )		
						Light	Dark	TWA	Light	Dark	TWA	Light	Dark	TWA	Light	Dark	TWA
ad-lib <sup>2</sup>	16	480	1.63	25.5	41	2.6	1.8	2.4	4.1	3.2	3.8	6.7	5.1	6.2	0.82	0.81	0.82
ad-lib <sup>2</sup>	16	482	1.53	23.6	41	2.5	1.8	2.3	5.1	3.5	4.6	7.6	5.3	6.8	0.93	0.95	0.94
no feed <sup>2</sup>	9	484	1.44	21.8	43	2.8	1.7	2.1	4.5	2.9	3.5	7.2	4.6	5.6	0.89	0.76	0.80
no feed <sup>2</sup>	9	486	1.38	21.5	45	2.3	1.5	1.8	3.2	2.3	2.6	5.5	3.9	4.5	0.67	0.68	0.67
no feed <sup>2</sup>	9	488	1.32	20.8	43	2.0	1.5	1.7	3.2	2.4	2.7	5.2	3.9	4.4	0.67	0.66	0.66
restricted <sup>2</sup>	9	490	1.26	21.0	41	2.3	1.8	2.0	4.8	3.9	3.9	7.1	5.8	5.9	0.66	0.64	0.65
restricted <sup>2</sup>	9	492	1.25	20.9	39	2.5	1.2	1.7	5.4	4.0	4.5	7.9	5.2	6.2	0.73	0.72	0.72
restricted <sup>2</sup>	9	494	1.26	21.1	40	2.4	1.6	1.9	5.2	4.3	4.6	7.7	5.8	6.5	0.81	0.79	0.80
restricted <sup>3</sup>	9	496	1.27	20.7	40	2.2	1.4	1.7	4.8	3.6	4.1	7.0	5.0	5.8	0.79	0.79	0.79
restricted <sup>3</sup>	9	499	1.26	20.7	38	2.0	1.2	1.5	4.3	3.7	3.9	6.3	4.9	5.4	0.78	0.78	0.78
restricted <sup>4</sup>	9	503	1.23	20.9	41	2.5	1.6	1.9	4.3	3.7	3.9	6.8	5.3	5.9	0.81	0.83	0.82
ad-lib <sup>2</sup>	13	506	1.26	24.4	38	2.8	2.0	2.4	4.9	3.6	4.3	7.6	5.6	6.7	0.88	0.99	0.93
ad-lib <sup>2</sup>	13	508	1.32	24.9	37	3.1	2.3	2.8	4.7	3.2	4.0	7.9	5.5	6.8	1.00	0.97	0.98
ad-lib <sup>2</sup>	13	510	1.37	24.9	38	3.3	2.4	2.9	4.8	3.1	4.0	8.0	5.5	6.9	0.95	0.95	0.95
ad-lib <sup>3</sup>	13	512	1.42	24.8	38	3.3	2.5	2.9	4.7	3.0	3.9	8.0	5.6	6.9	0.97	0.98	0.97
ad-lib <sup>3</sup>	13	515	1.45	24.6	37	2.9	2.0	2.5	5.1	3.5	4.4	8.0	5.5	6.9	0.87	0.83	0.85
ad-lib <sup>3</sup>	13	518	1.48	24.7	38	2.9	2.2	2.6	4.7	3.3	4.1	7.7	5.5	6.7	0.86	0.85	0.86
ad-lib <sup>3</sup>	13	521	1.48	24.8	39	3.1	2.5	2.8	4.5	3.2	3.9	7.6	5.7	6.8	0.88	0.86	0.87

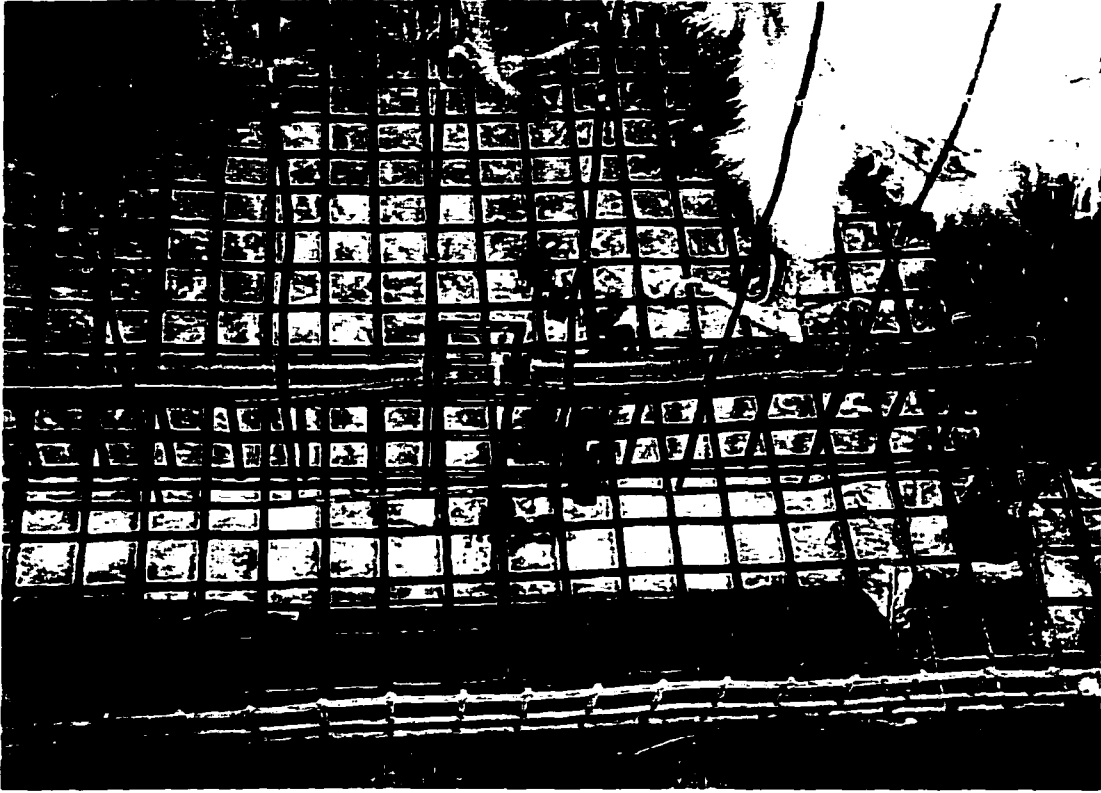
The superscripts indicate the number of days over which the variable means, including bird age, were calculated.

M = body mass, kg; T<sub>a</sub> = ambient temperature, °C; THP = total heat production rate; THP = LHP + SHP at corresponding light, dark, and TWA conditions



**Figure 1a. Laying hens during the fasting period.**

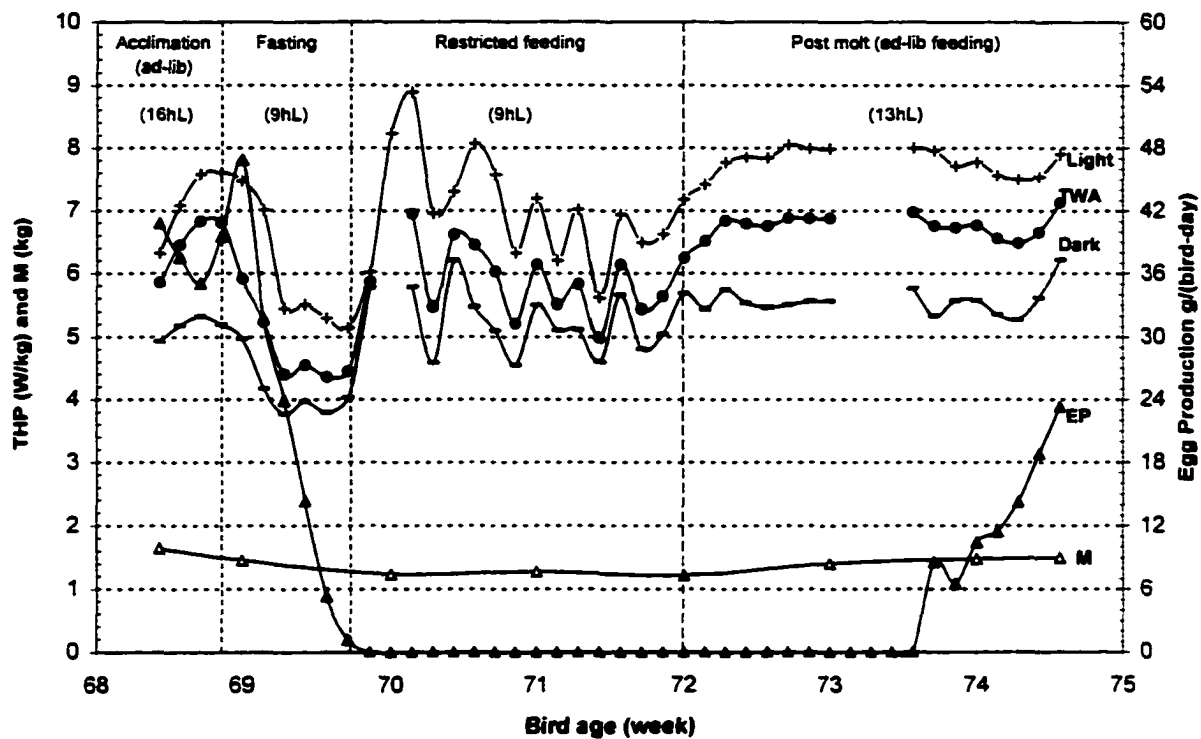




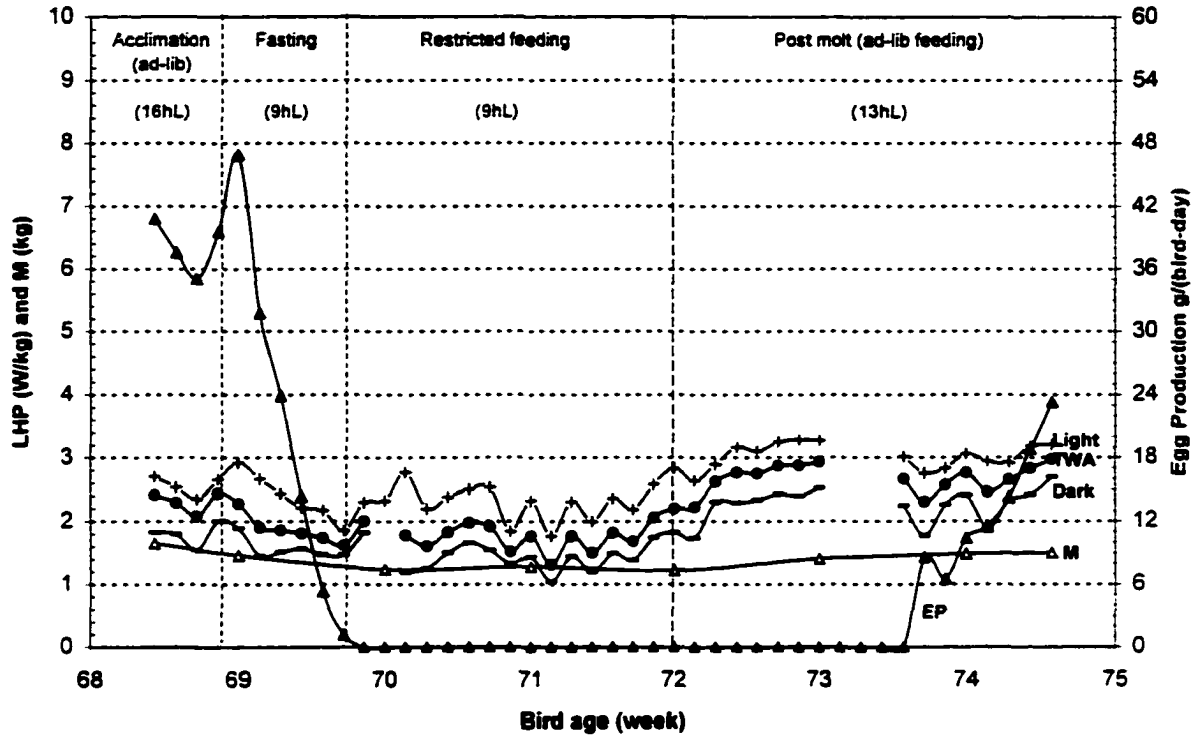
**Figure 1b. Loss of feathers during the restricted feeding period.**



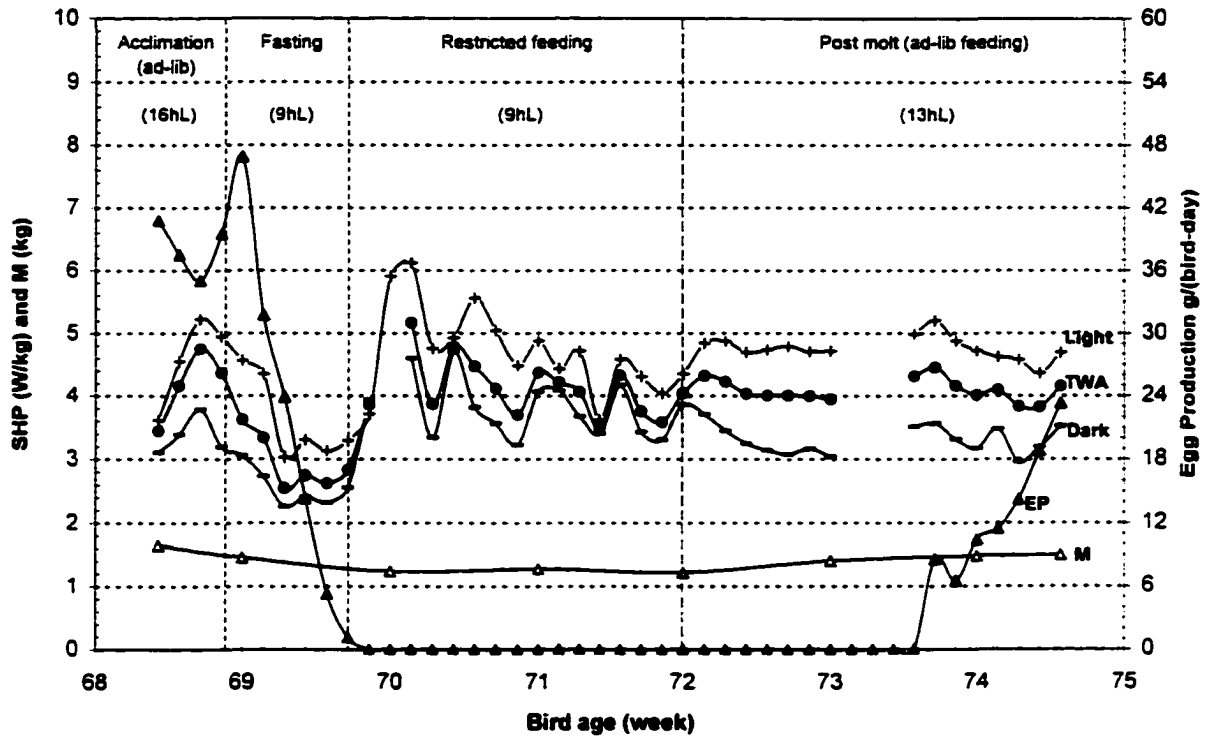
**Figure 1c. Feathers rejuvenating during the post molt period.**



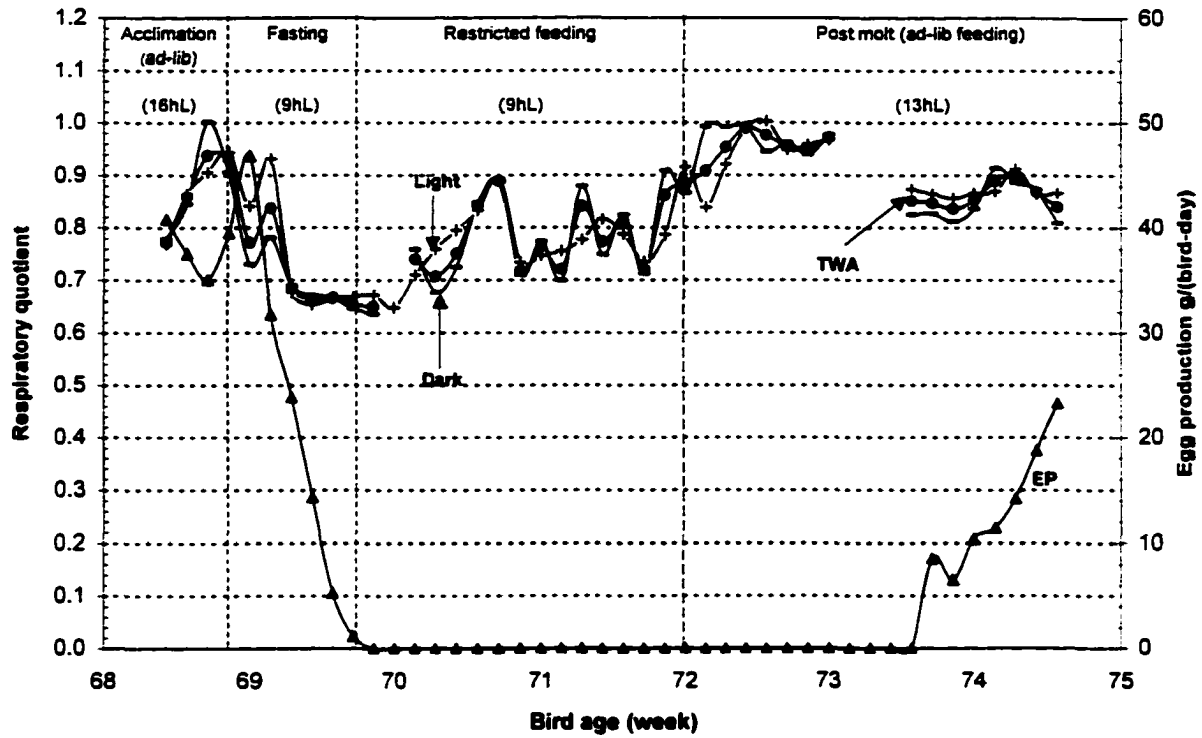
**Figure 2. Total heat production rate (THP), body mass (M), and egg production (EP) of molting W-36 laying hens as functions of bird age. TWA = time-weighted average.**



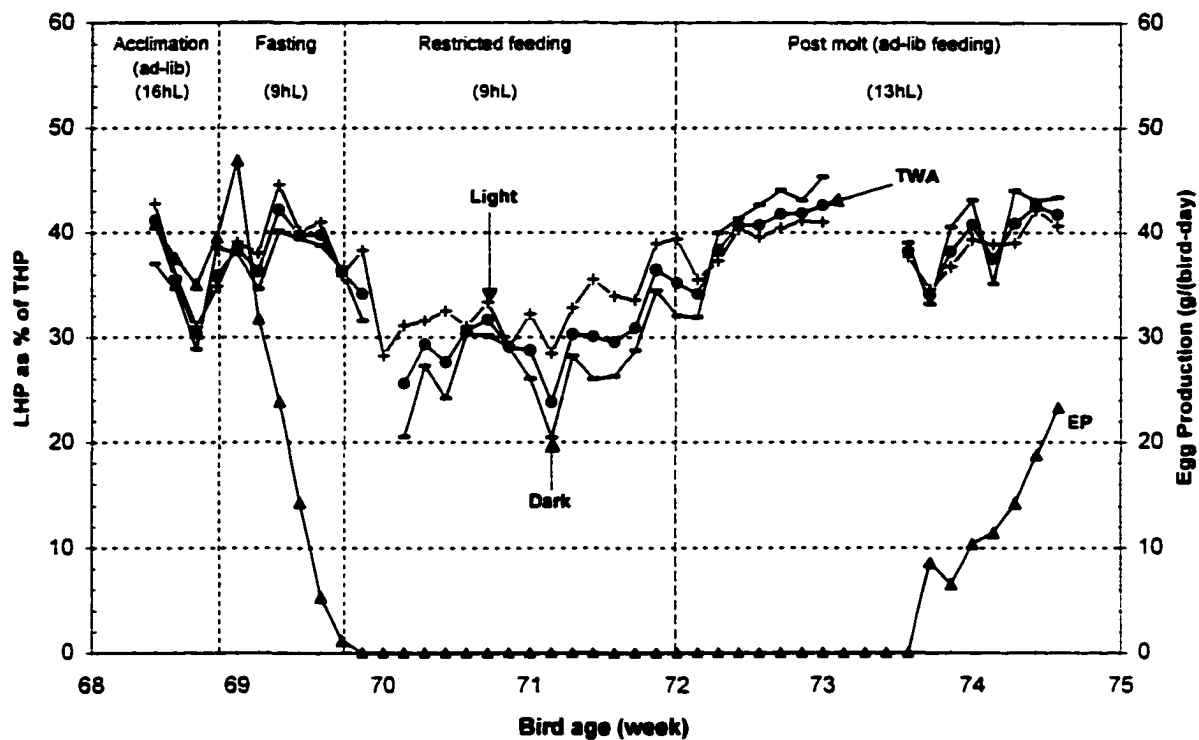
**Figure 3. Latent heat production rate (LHP), body mass (M), and egg production (EP) of molting W-36 laying hens as functions of bird age. TWA = time-weighted average.**



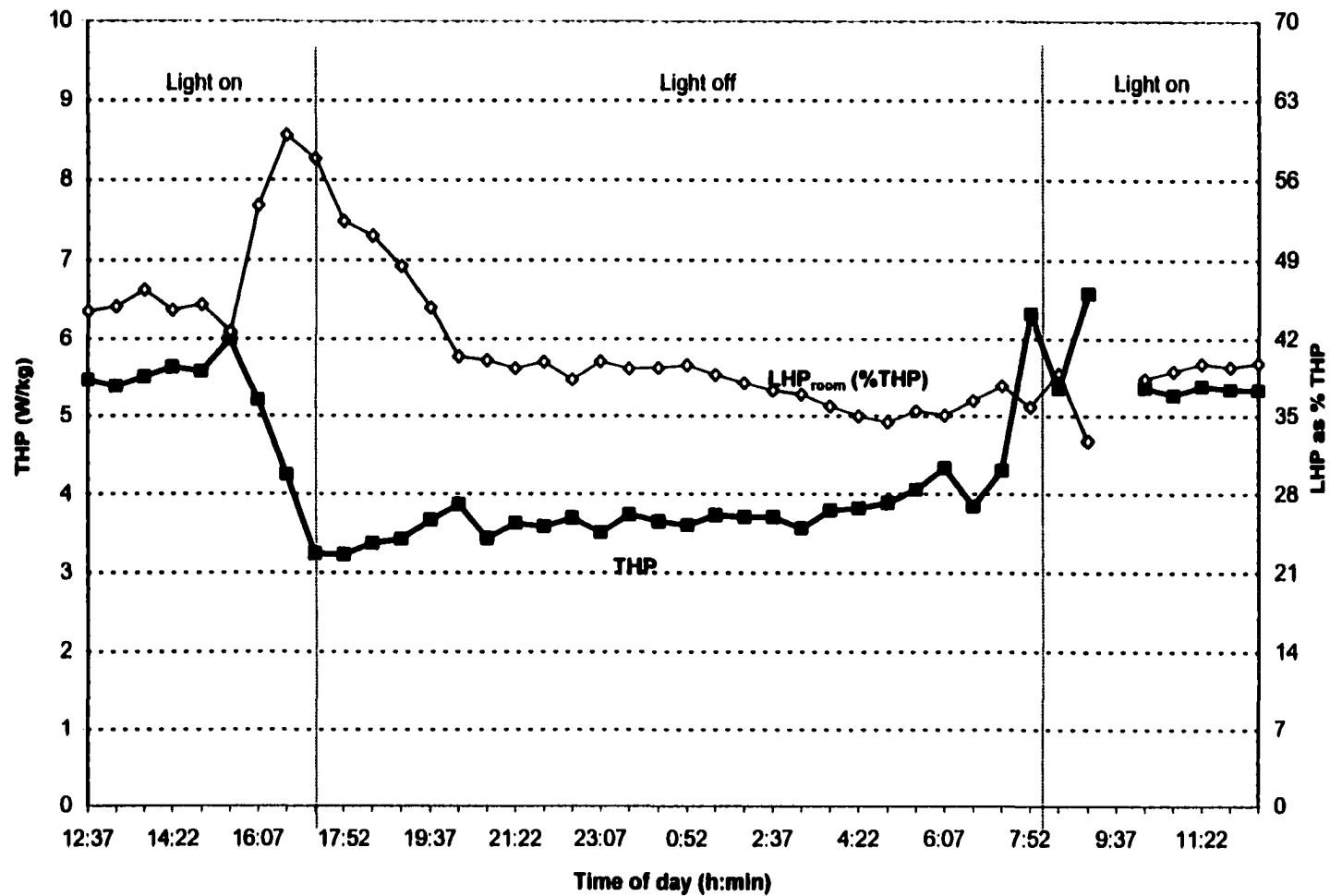
**Figure 4. Sensible heat production rate (SHP), body mass (M), and egg production (EP) of molting W-36 laying hens as functions of bird age. TWA = time-weighted average.**



**Figure 5. Respiratory quotient (RQ) and egg production (EP) of molting W-36 laying hens as functions of bird age. TWA = time-weighted average.**

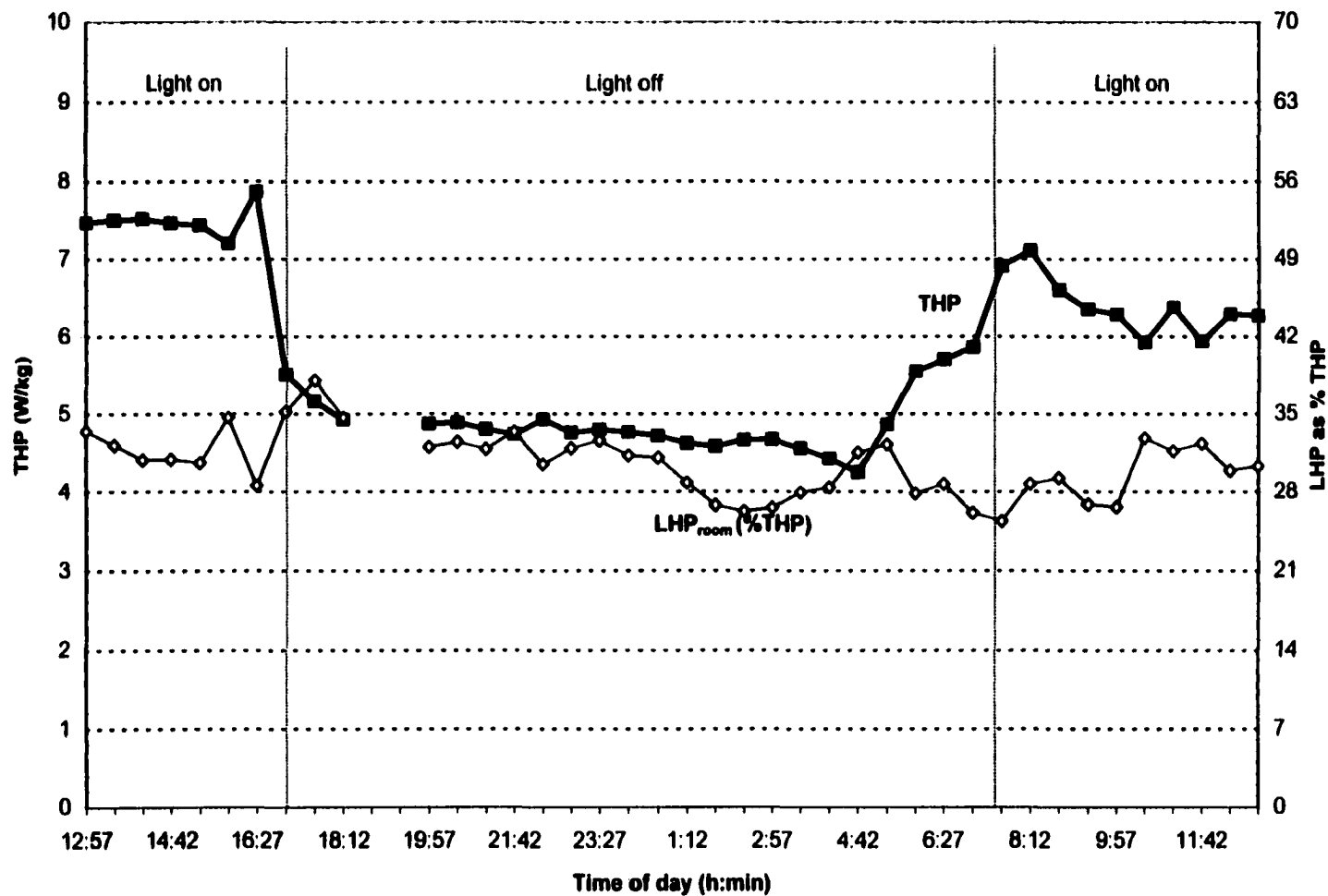


**Figure 6. Latent heat production rate (LHP) as a percentage of total heat production rate (THP) and egg production (EP) of molting W-36 laying hens as functions of bird age. TWA = time-weighted average.**

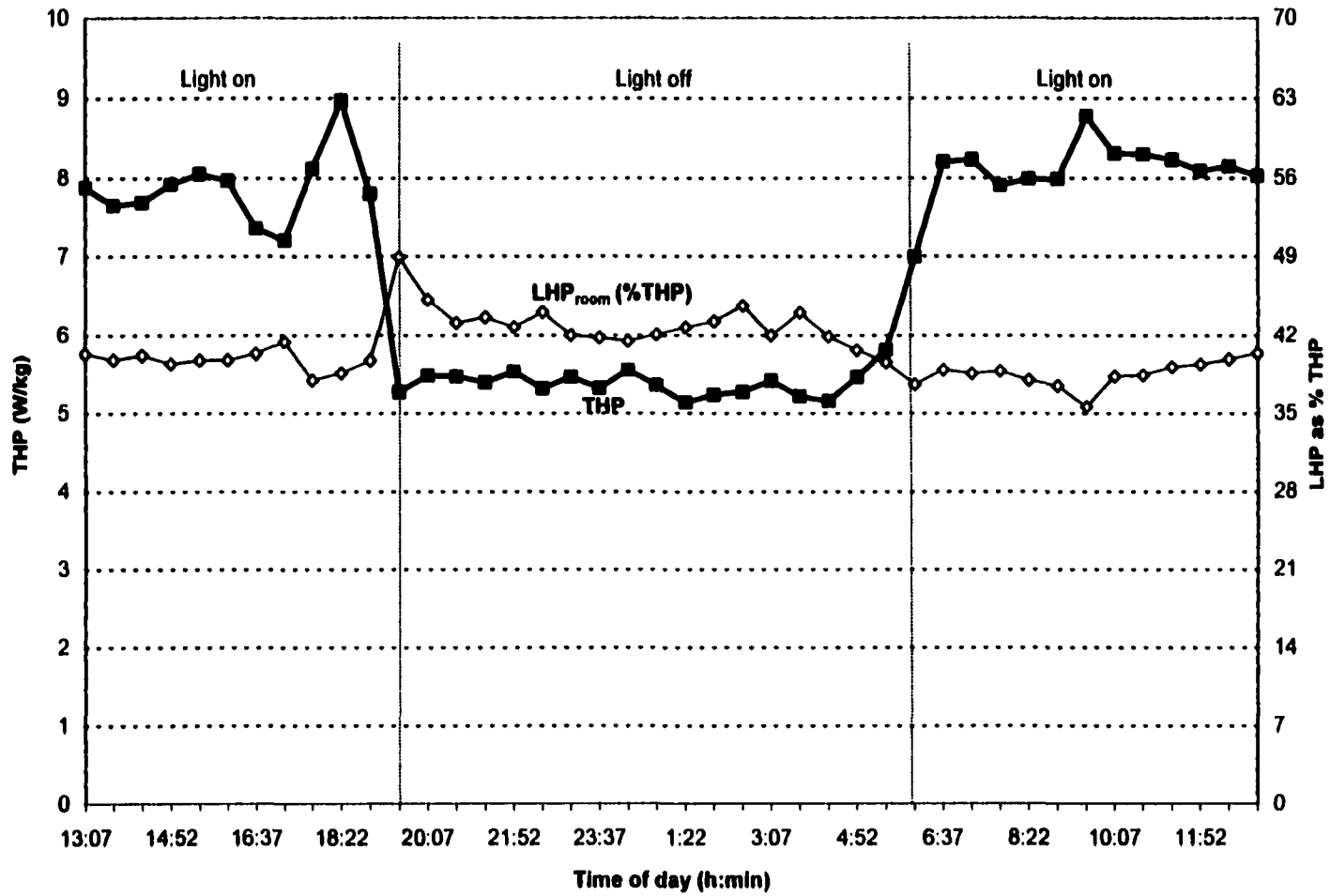


**Figure 7. Diurnal profiles of total heat production rate (THP), respiratory quotient (RQ), and latent heat production rate of the room (LHP<sub>room</sub>) as % THP for 69-week old W-36 layers during the fasting period under 22°C temperature. Birds had water from nipple drinkers. Both THP and LHP<sub>room</sub> are averaged over four chambers.**





**Figure 8. Diurnal profiles of total heat production rate (THP), respiratory quotient (RQ), and latent heat production rate of the room ( $LHP_{room}$ ) as % THP for 70-week old W-36 layers during the restricted feeding period under 21°C temperature. Birds had water from nipple drinkers. Both THP and  $LHP_{room}$  are averaged over four chambers.**



**Figure 9. Diurnal profiles of total heat production rate (THP), respiratory quotient (RQ), and latent heat production rate of the *room* (LHP<sub>room</sub>) as % THP for 72-week old W-36 layers during the post molt period under 24°C temperature. Birds had water from nipple drinkers. Both THP and LHP<sub>room</sub> are averaged over four chambers.**

**CHAPTER 5.****HEAT AND MOISTURE PRODUCTION OF POULTRY AND THEIR HOUSING SYSTEMS: AN APPLICATION IN BUILDING VENTILATION RATE DESIGN**

A paper to be submitted to the Journal of Applied Engineering in Agriculture

H. J. Chepete and H. Xin

**ABSTRACT**

The heat and moisture production (HP and MP) data recently collected by Chepete and Xin (2002a) for W-36 layers were used in an example of designing the building ventilation rates for a modern laying hen house in Iowa. Ventilation graphs were developed for a range of outside temperature ( $t_o$ ) of -25 to 10°C, at 5°C increments, outside relative humidity (RH) of 20 to 70%, and inside RH of 50, 60 and 70%. Comparative ventilation curves based on literature HP and MP data were also presented. The ventilation rate (VR) derived from the 'old' literature *room* sensible heat (SH) and MP data was 10% higher or 18% lower for temperature or moisture control, respectively, than that derived from the new data. Correspondingly, based on *bird* SH and MP data, VR derived from the 'old' literature data was 5% higher or 57% lower. Reducing the number of birds or stocking density by 31% to reflect the new animal welfare guidelines would slightly raise the balance temperature ( $t_{bal}$ , 1.0 to 1.3°C), thereby having rather negligible influence on the supplemental heat requirement of the house. Increasing the room RH from 50 to 60% or from 60 to 70% reduced the ventilation rate by 17 to 61% or by 15 to 38%, respectively.

**KEYWORDS:** Moisture control, Temperature control, Ventilation graph.

## **INTRODUCTION**

Heat and moisture production rates (HP and MP) from animals and their housing components provide fundamental data for the engineering design of a building environmental control system (ASAE, 2000; ASHRAE, 2001; CIGR, 1992). The design of heating, cooling and ventilation needs by a confinement building requires the knowledge of sensible HP (SHP) characteristics of the building, while determination of minimum ventilation rate (MVR) under cold climates generally relies on latent HP (LHP) or MP data (Xin et al., 1998). Provision of adequate MVR is crucial for dilution of aerial contaminants to keep them within acceptable limits for animal production (Feddes and DeShazer, 1988; Xin et al., 1996). Increased MVR increases the building heat loss, which will result in more fuel use and requirement of larger heating capacity (Xin et al., 1996).

To determine the MVR for animal housing, factors in addition to air temperature must be considered and criteria arising from the various factors may conflict. Humidity and other air contaminants may increase when the ventilation rate is low to the point where they dictate the MVR (Albright, 1990). A ventilation graph that describes the required ventilation rate as a function of outdoor temperature according to several criteria, such as temperature control, humidity control, and carbon dioxide control, is normally used to determine which design criterion dictates the MVR. Sensible energy and mass balances are used to determine the relationship between ventilation rate and outside air temperature based on these criteria (Albright, 1990; Gates et al., 1996).

Most of the current MVR design for poultry housing are based on the HP and MP data that are 20 to 50 years old (Chepete and Xin, 2002b). Recently, Xin et al. (1998) measured HP and MP of tom turkeys during the 5-week brooding-growing period and used

the MP data to estimate the MVR that was then compared with the literature (MWPS, 1990) recommendation. They found that the literature MVR was 165 to 557% and 20 to 49% higher than their study during the first week and the rest of the brooding period, respectively. Such comparisons have not been made for pullets and layers.

The objectives of this paper were to demonstrate the use of the newly collected HP and MP data by Chepete and Xin (2002a) in designing the ventilation rate for 37-week-old W-36 layers under selected environmental and housing conditions representative of those in Iowa; to compare the results with those derived from literature values; and finally to delineate the effects of reduced stocking density on the ventilation graphs, particularly balance temperature (i.e., outside temperature at or below which supplemental heat would be required to maintain the desired indoor conditions) or supplemental heat need.

## **MATERIALS AND METHODS**

### **Ventilation for Moisture Control**

The selected environmental conditions consisted of outside temperature ( $t_o$ ) ranging from -25 to 10°C, at 5°C increments. The inside temperature ( $t_i$ ) was 15, 20 or 25°C. The outside relative humidity ( $RH_o$ ) ranged from 20 to 70%, at 10% increments. The inside relative humidity ( $RH_i$ ) was 50, 60, or 70%.

The MVR was calculated as:

$$MVR = \frac{MP}{\rho \cdot (W_i - W_o) \cdot 1000} \quad [1]$$

The new MP data was obtained from Chepete and Xin (2002a) (for W-36 hens) while the 'old' data was obtained from Albright (1990) (for White leghorn hens) and Riskowski et al. (1978) (for W-36 hens). Specific sensible heat (SH) and MP data from the bird only (*bird*

MP) was obtained from Chepete and Xin (2002a) and Riskowski et al. (1978) while that from the birds and surroundings (*room* MP) was obtained from Chepete and Xin (2002a) and Albright (1990). The *room* data from Albright (1990) represent data that are currently used in the ASAE standards and can be compared with the new data by Chepete and Xin (2002a). The *bird* data from Chepete and Xin (2002a) and Riskowski et al. (1978) would demonstrate how the use of *bird* values would impact the ventilation rate as compared to the use of *room* values.

The air density,  $\rho$ , based on  $T_o$ , was calculated as the inverse of specific volume ( $v$ ) of moist air, calculated as:

$$v_{\text{moist air}} = \frac{(1/P_a)R_aT(1+1.6078W)}{1+W} \quad (\text{Albright, 1990}) \quad [2]$$

The humidity ratio ( $W$ ) for the inside or outside air was calculated as:

$$W = 0.62198 \left[ \frac{P_w}{P_a - P_w} \right] \quad (\text{Weiss, 1977}) \quad [3]$$

The partial vapor pressure ( $P_w$ ) of the inside or outside air was calculated as:

$$P_w = RH \times P_{ws} \quad [4]$$

The saturation vapor pressure of the inlet or outlet air ( $P_{ws}$ ), a function of dry bulb temperature, ( $T_{db}$ ) was calculated as such:

$$P_{ws}(T) = e^{\left[ C_1/T + C_2 + C_3 \cdot T + C_4 \cdot T^2 + C_5 \cdot T^3 + C_6 \cdot T^4 + C_7 \cdot \ln(T) \right]} \quad (\text{ASHRAE, 2001}) \quad [5]$$

For  $-100 \leq T_{db} \leq 0$  °C, the constants are:

$$C_1 = -5.6745359 \text{ E}+03, C_2 = 6.3925247 \text{ E}+00, C_3 = -9.677843 \text{ E}-03, \\ C_4 = 0.622157 \text{ E}-06, C_5 = 2.0747825 \text{ E}-09, C_6 = -0.9484024 \text{ E}-12$$

$$C_7 = 4.1635019 \text{ E}+00.$$

For  $0 \leq T_{db} \leq 200 \text{ }^\circ\text{C}$ , the constants are:

$$C_1 = -5.8002206 \text{ E}+03, C_2 = 1.3914993 \text{ E}+00, C_3 = -4.8640239 \text{ E}-02,$$

$$C_4 = 4.1764768 \text{ E}-05, C_5 = -1.4452093 \text{ E}-08, C_6 = 0.0,$$

$$C_7 = 6.5459673 \text{ E}+00.$$

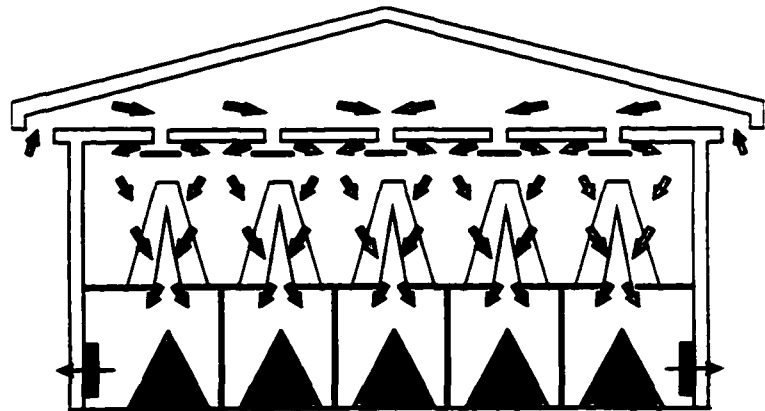
A convenient look-up table of ventilation rates under the different conditions was prepared based on the new MP obtained from Chepete and Xin (2002a).

### Ventilation for Temperature Control

In calculating the ventilation rates for temperature control, contributions of solar heat and heat from lights were ignored and the design was for the typical condition where only animal heat is available to warm the air. The energy balance is:

$$\dot{V}_{temp} = \frac{SH - (\sum UA + FP)(t_i - t_o)}{1006 \cdot \rho \cdot (t_i - t_o)} \quad [6]$$

A typical commercial high-rise layer house (fig. 1) located in Iowa, having dimensions 131.1m L  $\times$  14.6m W  $\times$  2.3m H (430' L  $\times$  48' W  $\times$  7.5' H) with a flat ceiling, was considered. The house has a nominal holding



**Figure 1. A schematic representation of cross-section of a high-rise layer house with negative pressure ventilation and continuous slot ceiling inlets.**

capacity of 84,000 birds. The new SH data was obtained from Chepete and Xin (2002a) (W-36) while the 'old' data was obtained from Albright (1990) (White leghorn) and Riskowski et al. (1978) (W-36). The inside and outside of the walls and ceiling were covered with 20 gauge tin. The walls were insulated with 0.152 m (6") of fiberglass batt while the ceiling was insulated with 0.303 m (12") of blown-in cellulose. The six walkways were made of 0.019 m (0.75") plywood. The five cage rows had 0.203 m (8") wide opening underneath to allow manure to fall into the storage below. The  $\Sigma UA$  term consisted of contributions from the walls, ceiling and the floor. The perimeter factor (FP) was zero because of the high-rise nature of the house. The  $t_i$  and  $t_o$  were as previously mentioned. A temperature differential of 5°C between the inside of the house and manure storage space was used as field measurement (Xin, 2002). The air density,  $\rho$ , was based on the outside air conditions and was derived from equation [2].

Ventilation curves relating ventilation rate and outside temperature were then generated for both temperature and moisture control under environmental conditions earlier mentioned. Currently, most birds are housed at 0.0355 m<sup>2</sup>/bird (55 in<sup>2</sup>/bird). Due to animal welfare concerns, a 31% increase in floor space (0.04645 m<sup>2</sup>/bird or 72 in<sup>2</sup>/bird), has been recommended. This implies a 31% reduction in the total number of birds per house and its effect on ventilation and heating requirement is investigated in this paper.



## RESULTS AND DISCUSSIONS

### Ventilation Rate Look-up Table

Table 1 shows the ventilation rate or MVR for the 37-week old W-36 birds under different environmental conditions. Higher ventilation rates are associated with lower  $t_i$  and  $RH_i$  and the opposite is true.

From table 1, it is evident that changes in  $RH_i$  directly affect the MVR. For example, an increase in  $RH_i$  from 50 to 60% reduced the MVR by 17 to 61% across the different environmental conditions examined. Similarly, when RH was increased from 60 to 70%, the MVR was reduced by 15 to 38%. When  $RH_i$  was increased from 50 to 60%, Xin et al. (1998) reported a MVR reduction of 50 to 60% across  $t_i$  of 21 to 29 °C,  $t_o$  of -23 to 10 °C, and  $RH_o$  of 20 to 90% on tom turkeys during brooding-growing period. As such, a temporary increase in  $RH_i$  would reduce heating and electricity costs on fan operation. However, Xin et al. (1998) cautioned that such practice should be done very carefully as it may result in ammonia build-up, excessive litter moisture and disease problems.

At cold  $t_o$ ,  $RH_o$  had little effect on MVR. For example, at  $t_o$  of -5 to -25 °C, the MVR values for  $RH_o$  of 20 to 70% are within 5% of each other. Xin et al. (1998) reported a 10% variation in MVR for  $t_o$  of -15 to -23 °C and  $RH_o$  of 20 to 90% and they attributed this finding to compliance with thermodynamic properties of air, where, as the air becomes colder its moisture content approaches similarity regardless of RH level.

The MWPS (1990) recommends a value of 0.1 cfm/lb or 0.375 m<sup>3</sup>/(h·kg) being the cold weather ventilation rate for layers. Based on this recommended MVR, the MVR based on the new MP data would be 0.56 m<sup>3</sup>/(h·bird) (0.33 cfm/bird). On the other hand, the

ventilation rate would be  $0.68 \text{ m}^3/(\text{h-bird})$  ( $0.40 \text{ cfm/bird}$ ). This suggests a 22% over ventilation for modern birds when the MWPS (1990) data are used. The MP data in the MWPS (1990) were based on the 'old' data, as reported in a literature review by Chepete and Xin (2002b), where a significant quantity of the moisture came from wasted drinking water. The MWPS did not define the environmental conditions that constitute a 'cold weather' condition and this may leave room for a wide range of assumptions when designing the MVR. A very convenient look-up table (table 1) provides more information and offers a solution to this discrepancy.

Similar calculations to generate MVR for other birds of different ages can be made by using the relevant MP data.

### **Ventilation Graphs**

The ventilation graphs for temperature and moisture control under different environmental conditions are shown in figures 2 through 13. Figures 2 through 7 are based on a total of 84,000 birds per house while figures 8 through 13 are based on a total of 57,960 birds per house, a 31% reduction. In order to make comparisons between the graphs, specific SH and MP data from different literature sources, namely, Chepete and Xin (2002a), Albright (1990), and Riskowski et al. (1978), were used. The ventilation rate calculations for both temperature and moisture control were based on bird mass of 1.5 kg.

In all figures, ventilation rate for temperature control derived from *room* SH data by Albright (1990) was 10% higher than that derived from *room* SH data by Chepete and Xin (2002a). This may be due to the higher *room* SH reported by Albright (1990) as compared to that reported by Chepete and Xin (2002a). Specifically, specific *room* SH was 4.02 W/kg for Albright (1990) and 3.70 W/kg for Chepete and Xin (2002a). The ventilation rate derived

from *bird* SH data by Riskowski et al. (1978) was 5% higher than that derived from *bird* SH data by Chepete and Xin (2002a). The *bird* SH used in the case of Riskowski et al. (1978) was 4.40 W/kg while that from Chepete and Xin (2002a) was 4.20 W/kg. The use of *bird* SH in ventilation rate design resulted in higher ventilation rate than when *room* values were used.

The ventilation rate for moisture control based on *room* MP data by Chepete and Xin (2002a) was 22% higher than that based on *room* MP data by Albright (1990). The MP of the *room* was 4.85 g/(h·kg) or 7.28 g/(h·bird) and 3.7 g/(h·kg) or 5.55 g/(h·bird) for Chepete and Xin (2002a) and for Albright (1990), respectively. The higher *room* MP for Chepete and Xin (2002a) may have caused higher ventilation rate when compared to that for Albright (1990). On the other hand, the moisture control curves based on *bird* MP data by Chepete and Xin (2002a) was 134% higher than that derived from *bird* MP data by Riskowski et al. (1978). The *bird* MP used in the case of Chepete and Xin (2002a) was 4.11 g/(h·kg) or 6.17 g/(h·bird) and was 1.76 g/(h·kg) or 2.64 g/(h·bird) for Riskowski et al. (1978). The lower *bird* MP value for Riskowski et al. (1978) may have caused the associated ventilation rate to remain consistently low.

Typically, for a poultry house, the *room* SH and MP data should be used in ventilation rate design because they take into account the effects of moisture evaporation from feces and surroundings. Lower ventilation rates result when *bird* values are used. For example, based on *room* SH and MP data by Chepete and Xin (2002a), the balance point ventilation rate was 2100 m<sup>3</sup>/(h·1000hd) (1236 cfm/1000hd) while that based on the corresponding *bird* values was 1200 m<sup>3</sup>/(h·1000hd) (706 cfm/1000hd) (fig. 2). Thus, the use of *bird* values underestimated the balance point ventilation rate by 75%.

***Effect of increasing  $RH_i$  on ventilation rate while holding  $t_i$  constant.*** The ventilation rate and balance temperature were reduced as  $RH_i$  was increased. For example, at 15°C room temperature, the balance point ventilation rate or ideal ventilation rate based on room SH and MP for Chepete and Xin (2002a) reduced from 2100 to 800 m<sup>3</sup>/(h·1000hd) (1236 to 471 cfm/1000hd) while that by Albright (1990) reduced from 1200 to 600 m<sup>3</sup>/(h·1000hd) (706 to 353 cfm/1000hd) when  $RH_i$  was increased from 50% (fig. 2) to 70% (fig. 3). The balance temperature was correspondingly reduced from 8 to -1.5°C, and from 3.5 to -10°C. This agrees well with psychrometric principles (ASHRAE, 2001) that to keep the same temperature in the room while increasing the room RH, colder air should be brought in so as to avoid high room temperature buildup. Air with higher moisture content holds more heat energy than drier one. The MWPS (1990) specifies a minimum  $t_i$  of 12.8°C (55F) and  $RH_i$  of 50 to 70%.

Similar observations and arguments can be made for other pairs of graphs, namely figures 4 vs. 5; 6 vs 7; 8 vs. 9; 10 vs. 11; and 12 vs. 13. The relative magnitudes of the values would be different between the pairs as different environmental conditions are considered.

***Effect of increasing  $t_i$  on ventilation rate while holding  $RH_i$  constant.*** In order to illustrate the effect of increasing  $t_i$  on ventilation rate while holding  $RH_i$  constant, comparisons may be made between figures 2, 4, and 6 at  $RH_i$  of 50% and 100% stocking capacity, figures 3, 5, and 7 at  $RH_i$  of 70% and 100% stocking capacity; figures 8, 10, and 12 at  $RH_i$  of 50% and 69% stocking capacity, and figures 9, 11, and 13 at  $RH_i$  of 70% and 69% stocking capacity.

At  $RH_i$  of 50% (figures 2, 4, 6, 8, 10, and 12), increasing the room temperature from 15 to 25°C resulted in reduction in the ventilation rate. This is logical because in order to

maintain higher room temperature, the ventilation rate should be reduced in order to minimize sensible heat loss via exhaust air. The greater reduction in moisture control-MVR as a result of maintaining the constant  $RH_i$  at a higher  $t_i$  led to a lower balance temperature.

Different data used gave different ventilation rates. For example, considering the ventilation curves for moisture and temperature control derived from *room* SH and MP data by Chepete and Xin (2002a) and Albright (1990), the ventilation rates at the balance point were 2100 vs. 1200  $m^3/(h \cdot 1000hd)$  (1236 vs. 706 cfm/1000hd), respectively (fig. 2). This may be a result of modern birds producing lesser SH and more moisture than birds reared several years ago as indicated by comparison of *room* SH and MP reported by Chepete and Xin (2002a) and Albright (1990). The corresponding balance point ventilation rate for 20 and 25°C (figures 4 and 6, respectively) were 940 vs. 600  $m^3/(h \cdot 1000hd)$  (553 vs. 353 cfm/1000hd) and 520 vs. 360  $m^3/(h \cdot 1000hd)$  (306 vs. 212 cfm/1000hd), respectively.

The balance point ventilation rate based on *bird* SH and MP data by Chepete and Xin (2002a) was 1200, 630, and 350  $m^3/(h \cdot 1000hd)$  (706, 371, and 206 cfm/1000hd) at corresponding temperatures of 15, 20, and 25°C and 50% RH (fig. 2, 4, and 6, respectively). Ventilation rate for moisture control based on *bird* MP data by Riskowski et al. (1978) did not coincide with the corresponding temperature control curve. This may be caused by the low *bird* MP value that caused the ventilation rate for moisture control to be consistently low.

For a given  $t_o$ , ventilation for temperature control using *room* SH and MP data by Albright (1990) resulted in higher ventilation rate than when the new data by Chepete and Xin (2002a) was used. This suggests potential over ventilation for the modern birds when using the 'old' data and this may lower  $RH_i$  and cause dusty conditions that may further cause respiratory disorders in the birds (MWPS, 1990).

For 70% RH<sub>i</sub> (figures 3, 5, 7, 9, 11, and 13), similar observations and arguments can be made.

***Effect of reducing the stocking capacity by 31% on the ventilation rate.*** Under similar environmental conditions, the only difference observed between figures 2 through 7 (100% stocking capacity) and figures 8 through 13 (69% stocking capacity) would be due to the different bird numbers resulting in lower net sensible heat when the bird capacity was reduced. For example, comparing results of figure 2 (100% stocking capacity, 50% RH and 15°C temperature) vs. figure 8 (69% stocking capacity, 50% RH and 15°C temperature), the balance point ventilation rate was 2100 vs. 2300 m<sup>3</sup>/(h·1000hd) (1236 vs. 1354 cfm/1000hd), respectively, based on data by Chepete and Xin (2002a), and was 1200 vs. 1300 m<sup>3</sup>/(h·1000hd) (706 vs. 765 cfm/1000hd) based on data by Albright (1990). The corresponding balance temperature was 8.0 vs. 9.0°C and 3.2 vs. 4.5°C. Hence, the reduced number of birds would have rather insignificant effect on the building supplemental heat requirement. This is logical as most of the heat loss is through ventilation pathway that is directly related to moisture control MVR. Similar observations and arguments can be made by comparing figures 3 vs. 9, 4 vs. 10, 5 vs. 11, 6 vs. 12, and 7 vs. 13.

## **CONCLUSIONS**

The use of the newly collected heat and moisture production (HP and MP) data by Chepete and Xin (2002a) in designing the ventilation rate (VR) for 37-week-old W-36 layers under selected environmental and housing conditions representative of those in Iowa has been demonstrated and the results were compared with those derived from the literature. The effects of reduced stocking density on the ventilation graphs, particularly balance

temperature or supplemental heat need have been investigated. The following conclusions have been drawn:

- VR derived from the 'old' literature *room* sensible heat (SH) and MP data was 10% higher or 18% lower for temperature or moisture control, respectively, when compared to that derived from the new data.
- Correspondingly, the VR derived from the 'old' literature *bird* SH and MP data was 5% higher or 57% lower.
- Reducing the bird stocking density by 31% would slightly raise the balance temperature (1.0 to 1.3°C), thereby having little influence on supplemental heat requirement.
- Increasing the inside relative humidity (RH) from 50 to 60% or from 60 to 70% reduced the ventilation rate by 17 to 61% or by 15 to 38%, respectively.
- Under cold outside temperatures of -5 to -25°C, outside RH had little effect on the ventilation rate.

## REFERENCES

Albright, L. D. 1990. Environment control for animals and plants. ASAE. St. Joseph, MI.

ASAE Standards, 47<sup>th</sup> Ed. 2000. EP270.5. Design of ventilation systems for poultry and livestock shelters, 594. St. Joseph, Mich.: ASAE.

ASHRAE Handbook. Fundamentals. 2001. American Society of Heating, Refrigerating and Air Conditioning Engineers, Inc Atlanta, Ga.

Chepete, H. J. and Xin. H. 2002a. Heat and moisture production of poultry and their housing systems: *Pullets and Layers*. *Transactions of the ASHRAE* (In review).

- Chepete, H. J. and Xin, H. 2002b. Heat and moisture production of poultry and their housing systems: *Literature Review. Transactions of the ASHRAE* (In press).
- CIGR. 1992. 2<sup>nd</sup> Ed. 2<sup>nd</sup> *Report of Working Group on Climatization of Animal Houses*, 18-19. Gent, Belgium: Center for Climatization of Animal Houses-Advisory Services, Faculty of Agricultural Sciences, State University of Ghent.
- Feddes, J. J. R. and DeShazer J. A. 1988. Feed consumption as a parameter for establishing minimum ventilation rates. *Transactions of the ASAE* 31(2):571-575.
- Gates, R. S., Overhults D. G., and Zhang S. H. 1996. Minimum ventilation for modern broiler facilities. *Transactions of the ASAE* 39(3):1135-1144.
- MWPS-34. 1990. Heating, Cooling, and Tempering air for Livestock Housing. Ames, Iowa: Iowa State University.
- Riskowski, G. L., DeShazer J. A., and Mather F. B. 1978. Heat losses of White Leghorn laying hens as affected by intermittent lighting schedules. *Transactions of the ASAE* 20(4):727-731.
- Weiss, A. 1977. Algorithms for the calculation of moist air properties on a hand calculator. *Transactions of the ASAE* 20(4):1133-1136.
- Xin, H. 2002. *Personal communication*. Ames, Iowa: Iowa State University.
- Xin, H., Chepete H. J., Shao J., and Sell J. L. 1998. Heat and moisture production and minimum ventilation requirements of tom turkeys during brooding-growing period. *Transactions of the ASAE* 41(5):1489-1498.
- Xin, H., Berry I. L., and Tabler G. T. 1996. Minimum ventilation requirement and associated energy cost for aerial ammonia control in broiler houses. *Transactions of the ASAE* 39(2):645-648.



**NOMENCLATURE**

$\rho$  = air density,  $\text{kg}/\text{m}^3$  (based on outside air temperature)

'<sub>i</sub>' or '<sub>o</sub>' = inside or outside

$\dot{V}_{temp}$  = ventilation rate for temperature control,  $\text{m}^3/\text{s}$

A = area,  $\text{m}^2$

e = base of the natural logarithms, 2.7182818

F = perimeter heat loss factor,  $\text{W}/(\text{m}\cdot^\circ\text{C})$

MP = moisture production rate,  $\text{g}/(\text{kg}\cdot\text{h})$

MVR = minimum ventilation rate,  $\text{m}^3/(\text{kg}\cdot\text{h})$

P = perimeter, m

$P_a$  = barometric pressure of ambient air, kPa, assumed to be 101.325 kPa.

$P_w$  = partial vapor pressure of the inside or outside air, kPa

$P_{ws}$  = saturation vapor pressure of the inlet or outlet air, kPa

$R_a$  = dry air gas constant,  $287.055 \text{ J}/(\text{kg}\cdot\text{K})$

RH = relative humidity, %

SH = specific sensible heat production rate,  $\text{W}/\text{kg}$

T = absolute dry bulb temperature,  $\text{K} = ^\circ\text{C} + 273.15$

t = dry bulb temperature,  $^\circ\text{C}$

U = thermal conductance,  $\text{W}/(\text{m}^2\cdot^\circ\text{C})$

$v$  = specific volume,  $\text{m}^3/\text{kg}$

$W_i$  or  $W_o$  = humidity ratio for the inside (exhaust) or outside (fresh) air,  $\text{kg H}_2\text{O}/\text{kg dry air}$

**Table 1. Minimum ventilation rate ( $\text{m}^3/(\text{h}\cdot 1000\text{hd})$ ) for moisture control for 37-week old W-36 layers with a moisture production rate of  $4.85 \text{ g}/(\text{h}\cdot\text{kg})$  and bird mass of  $1.48 \text{ kg}$ .**

$t_o$ (°C)	$\text{RH}_o$ (%)	$t_i = 15^\circ\text{C}$			$t_i = 20^\circ\text{C}$			$t_i = 25^\circ\text{C}$		
		$\text{RH}_i$ (%)			$\text{RH}_i$ (%)			$\text{RH}_i$ (%)		
		50	60	70	50	60	70	50	60	70
-25	20	837	695	594	578	479	409	403	334	285
-20		861	714	609	593	491	419	413	342	292
-15		890	736	627	610	505	430	424	351	299
-10		925	762	648	630	520	443	436	360	307
-5		972	797	675	656	539	458	451	372	316
0		1038	843	710	689	564	477	469	385	326
5		1125	903	754	731	594	499	491	401	339
10		1255	989	815	789	634	529	520	422	354
-25	30	843	699	596	580	481	410	405	335	286
-20		871	720	614	597	494	421	415	344	293
-15		905	746	635	617	510	434	427	353	301
-10		952	780	661	642	529	449	442	364	310
-5		1017	827	696	676	553	467	460	378	320
0		1117	895	746	723	586	493	485	396	334
5		1260	988	812	786	629	524	516	418	350
10		1504	1137	914	881	692	569	559	447	372
-25	40	848	702	599	583	483	412	406	336	286
-20		880	727	618	601	497	424	417	345	294
-15		922	757	642	624	515	437	431	356	302
-10		980	799	674	655	537	455	448	368	312
-5		1066	859	719	697	567	478	470	385	325
0		1209	953	786	761	611	510	501	407	342
5		1432	1091	881	850	670	552	542	435	363
10		1876	1339	1039	997	761	615	603	475	391
-25	50	854	706	602	585	485	413	407	337	287
-20		890	733	623	606	500	426	419	347	295
-15		938	769	651	632	520	441	435	358	304
-10		1009	819	688	668	546	461	454	372	315
-5		1121	894	743	720	582	488	481	392	330
0		1317	1019	830	802	637	528	519	418	350
5		1659	1218	962	925	716	583	572	454	376
10		2496	1627	1205	1149	847	670	656	507	413

**Table 1. (continued)**

$t_o$ (°C)	RH <sub>o</sub> (%)	$t_i = 15^\circ\text{C}$			$t_i = 20^\circ\text{C}$			$t_i = 25^\circ\text{C}$		
		RH <sub>i</sub> (%)			RH <sub>i</sub> (%)			RH <sub>i</sub> (%)		
		50	60	70	50	60	70	50	60	70
-25	60	860	710	605	588	486	414	408	338	288
-20		900	740	628	611	503	428	422	348	296
-15		956	780	659	640	525	445	438	361	306
-10		1041	839	703	682	555	468	460	377	318
-5		1181	932	769	744	598	499	491	399	335
0		1447	1095	880	849	666	548	538	431	359
5		1972	1379	1059	1015	768	617	605	475	390
10		3729	2074	1435	1356	954	735	718	544	437
-25	70	865	714	608	591	488	416	410	339	288
-20		910	747	633	615	507	430	424	350	297
-15		974	792	667	648	531	449	442	363	308
-10		1074	861	718	696	564	474	467	381	322
-5		1248	973	797	771	615	511	503	406	340
0		1605	1183	936	901	698	569	559	444	368
5		2431	1589	1179	1124	829	656	643	497	405
10		7383	2863	1773	1654	1093	815	795	586	464

$t_o$  = outside temperature; RH<sub>o</sub> = outside relative humidity; RH<sub>i</sub> = inside relative humidity

$t_i$  = inside temperature; Divide the table values (SI unit) by 1.699 to obtain MVR in cfm (m<sup>3</sup>/ft) (IP unit) per 1,000 heads.

The moisture production (MP) used in the calculation of the minimum ventilation rate was calculated from the time-weighted average latent heat production (LHP) rate which included the contribution of moisture evaporation from fecal matter:  $MP = LHP * 3600 / 2450$

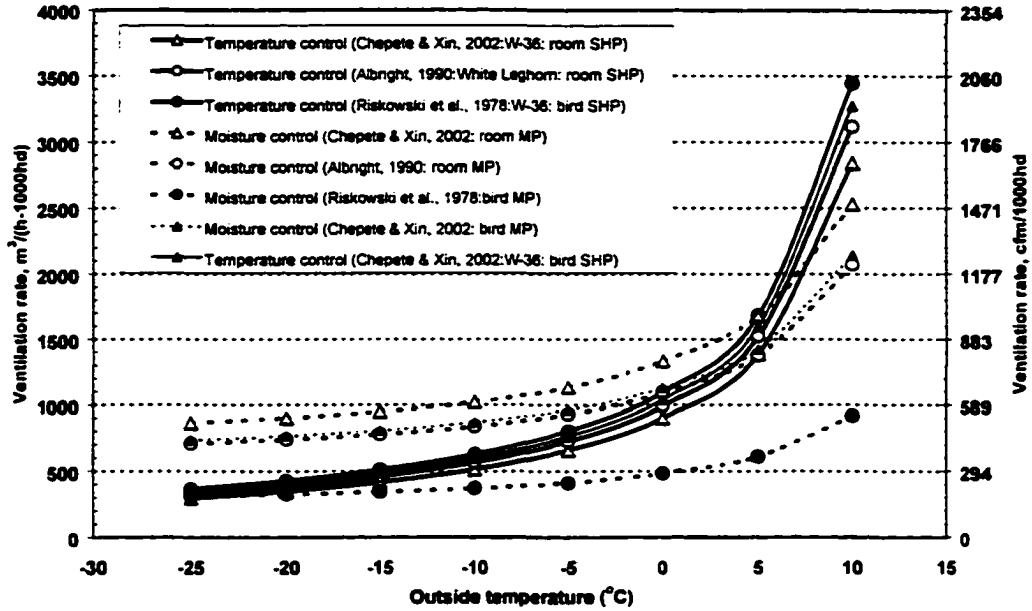


Figure 2. Ventilation graph based on outside air for temperature and moisture control at 100% stocking capacity, inside temperature of 15°C, inside relative humidity (RH) of 50%, and outside RH of 50%. Bird MP or SHP involve moisture effect from birds only; room MP or SHP involve moisture effect from birds and surroundings.

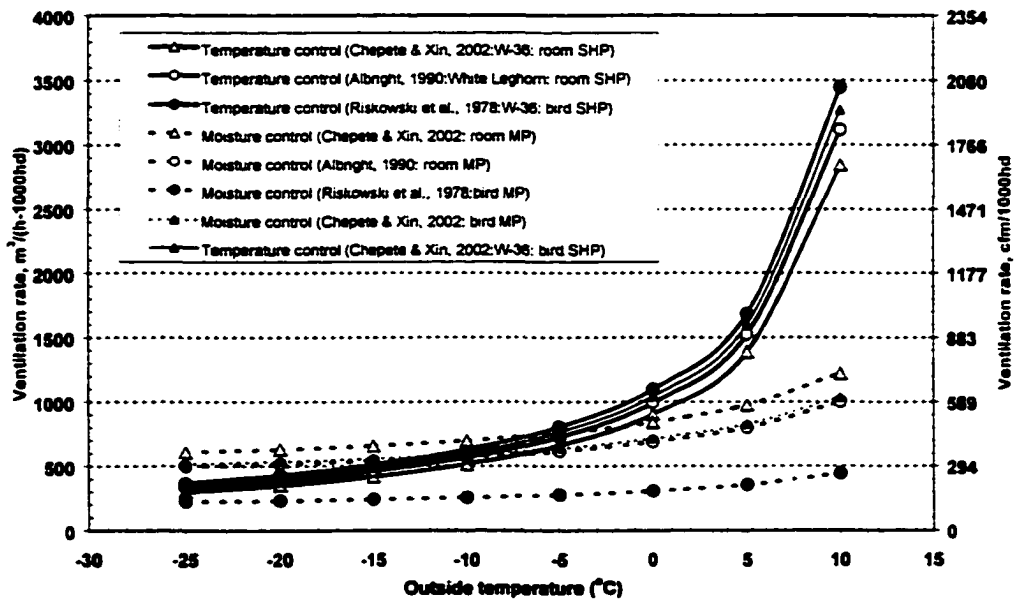


Figure 3. Ventilation graph based on outside air for temperature and moisture control at 100% stocking capacity, inside temperature of 15°C, inside relative humidity (RH) of 70%, and outside RH of 50%. Bird MP or SHP involve moisture effect from birds only; room MP or SHP involve moisture effect from birds and surroundings.

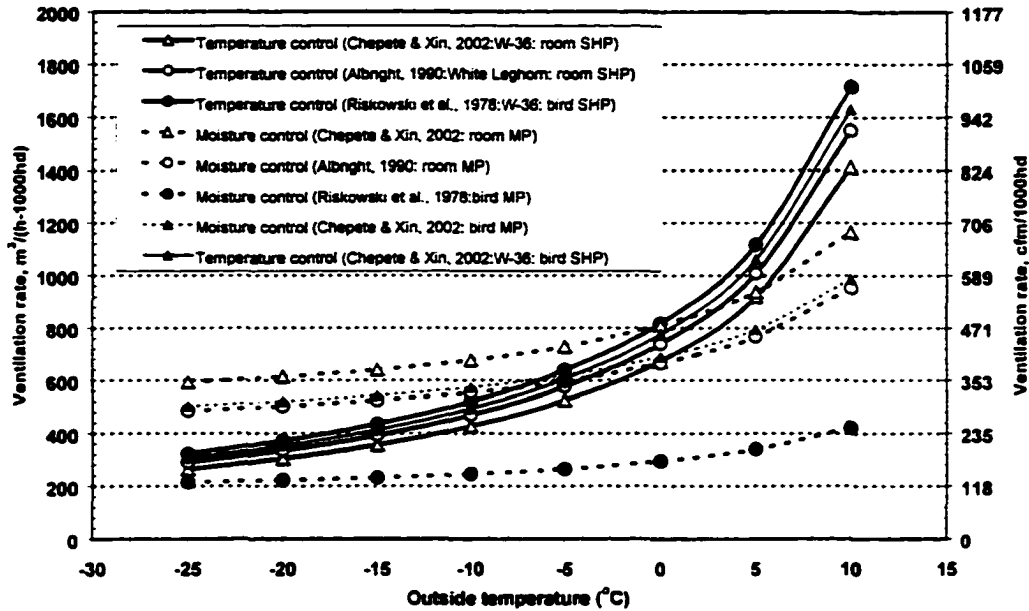


Figure 4. Ventilation graph based on outside air for temperature and moisture control at 100% stocking capacity, inside temperature of 20°C, and inside relative humidity (RH) of 50%, and outside RH of 50%. Bird MP or SHP involve moisture effect from birds only; room MP or SHP involve moisture effect from birds and surroundings.

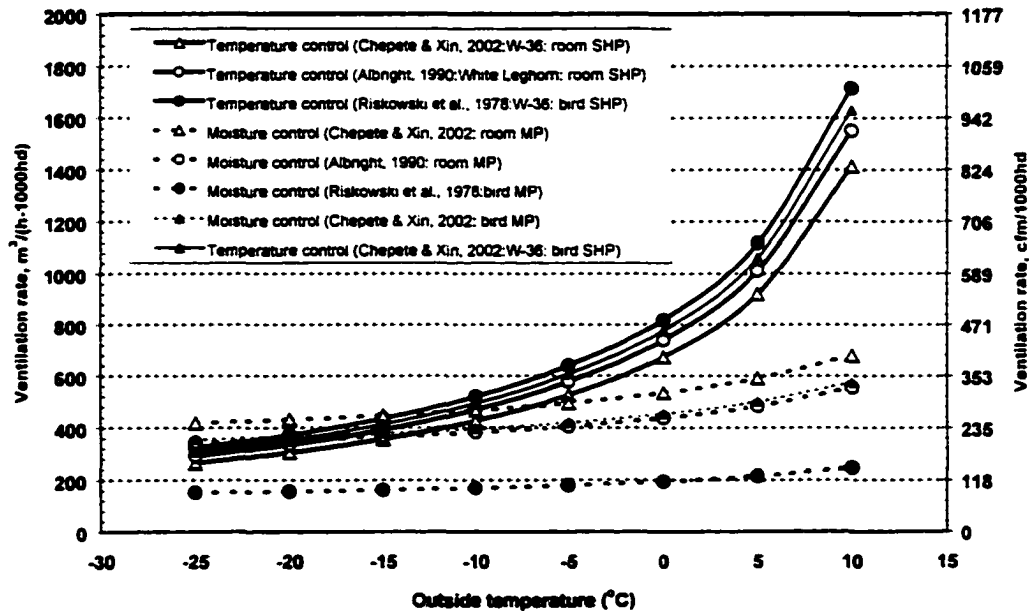


Figure 5. Ventilation graph based on outside air for temperature and moisture control at 100% stocking capacity, inside temperature of 20°C, and inside relative humidity (RH) of 70%, and outside RH of 50%. Bird MP or SHP involve moisture effect from birds only; room MP or SHP involve moisture effect from birds and surroundings.

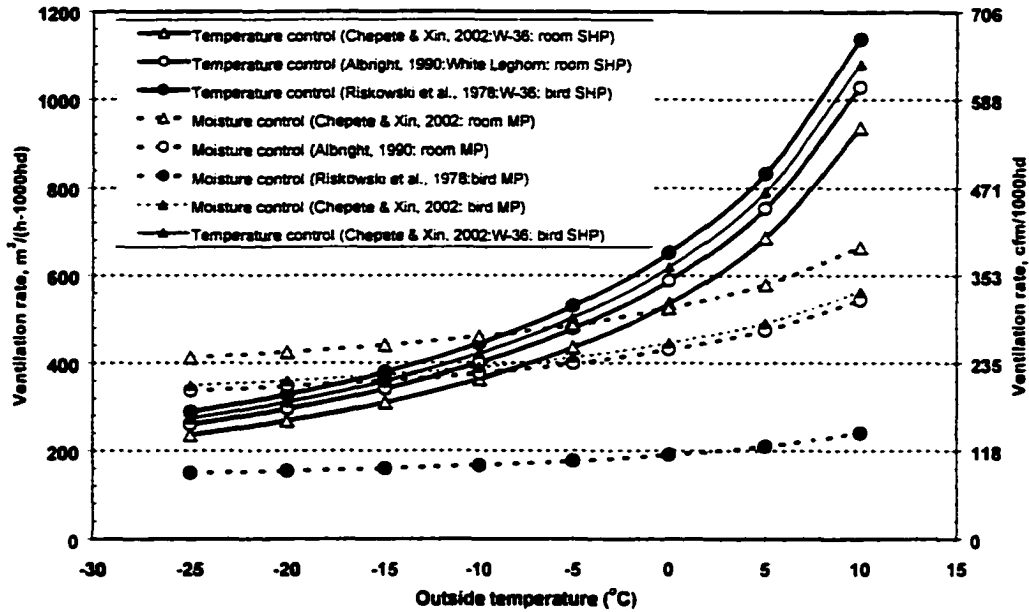


Figure 6. Ventilation graph based on outside air for temperature and moisture control at 100% stocking capacity, inside temperature of 25°C, and inside relative humidity (RH) of 50%, and outside RH of 50%. Bird MP or SHP involve moisture effect from birds only; room MP or SHP involve moisture effect from birds and surroundings.

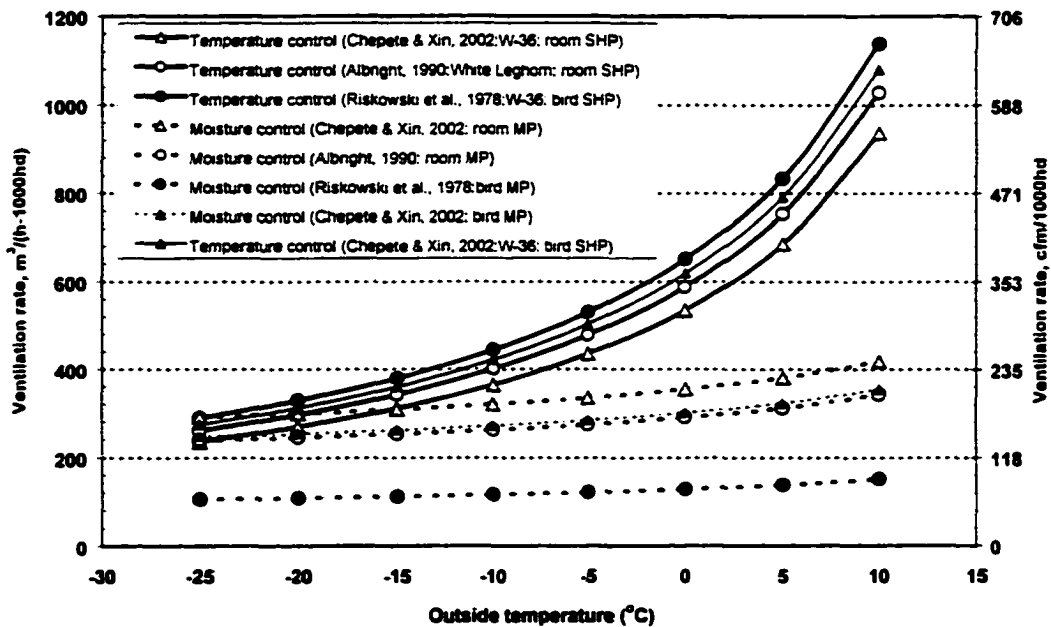


Figure 7. Ventilation graph based on outside air for temperature and moisture control at 100% stocking capacity, inside temperature of 25°C, and inside relative humidity (RH) of 70%, and outside RH of 50%. Bird MP or SHP involve moisture effect from birds only; room MP or SHP involve moisture effect from birds and surroundings.

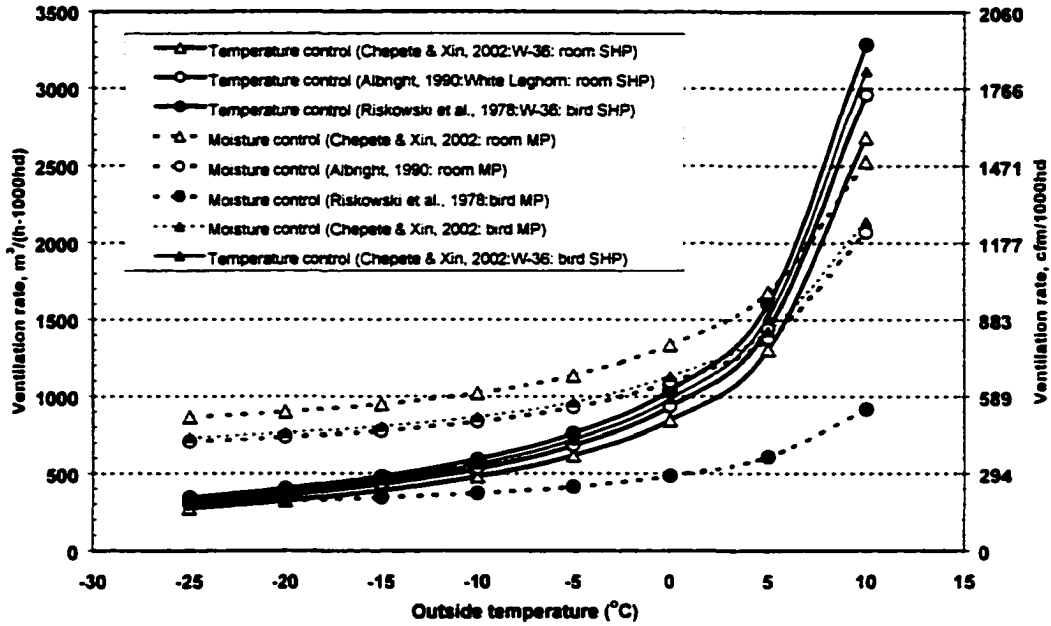


Figure 8. Ventilation graph based on outside air for temperature and moisture control at 69% stocking capacity, inside temperature of 15°C, and inside relative humidity (RH) of 50%, and outside RH of 50%. Bird MP or SHP involve moisture effect from birds only; room MP or SHP involve moisture effect from birds and surroundings.

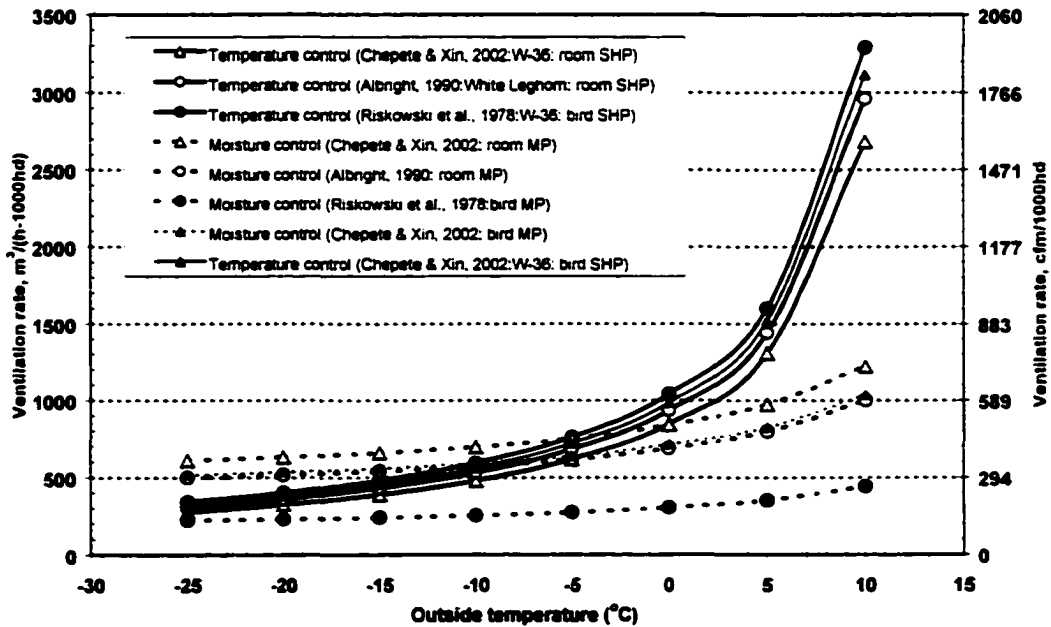


Figure 9. Ventilation graph based on outside air for temperature and moisture control at 69% stocking capacity, inside temperature of 15°C, and inside relative humidity (RH) of 70%, and outside RH of 50%. Bird MP or SHP involve moisture effect from birds only; room MP or SHP involve moisture effect from birds and surroundings.

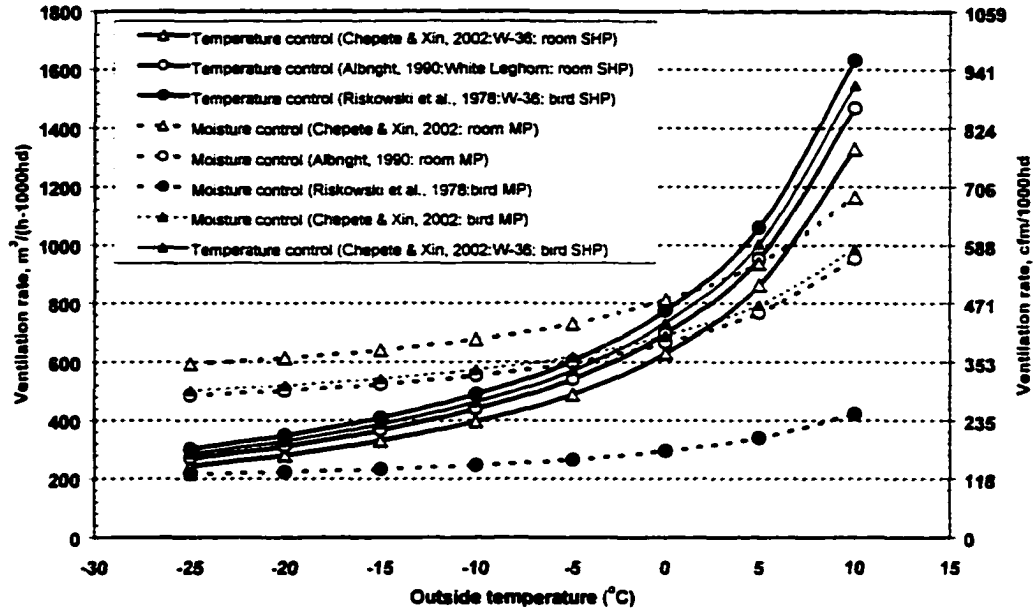


Figure 10. Ventilation graph based on outside air for temperature and moisture control at 69% stocking capacity, inside temperature of 20°C, and inside relative humidity (RH) of 50%, and outside RH of 50%. Bird MP or SHP involve moisture effect from birds only; room MP or SHP involve moisture effect from birds and surroundings.

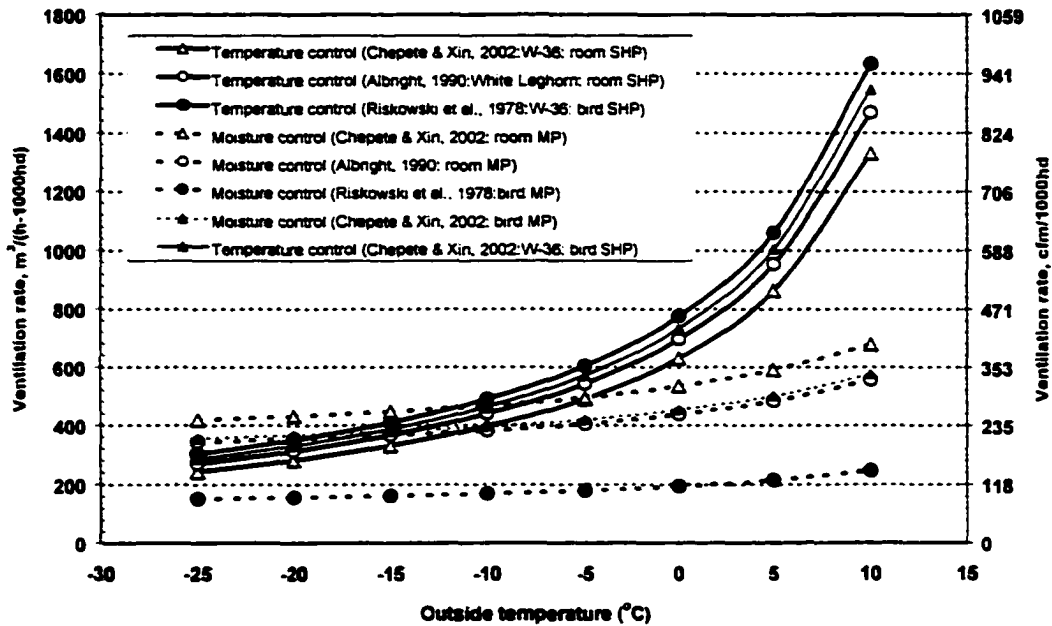


Figure 11. Ventilation graph based on outside air for temperature and moisture control at 69% stocking capacity, inside temperature of 20°C, and inside relative humidity (RH) of 70%, and outside RH of 50%. Bird MP or SHP involve moisture effect from birds only; room MP or SHP involve moisture effect from birds and surroundings.



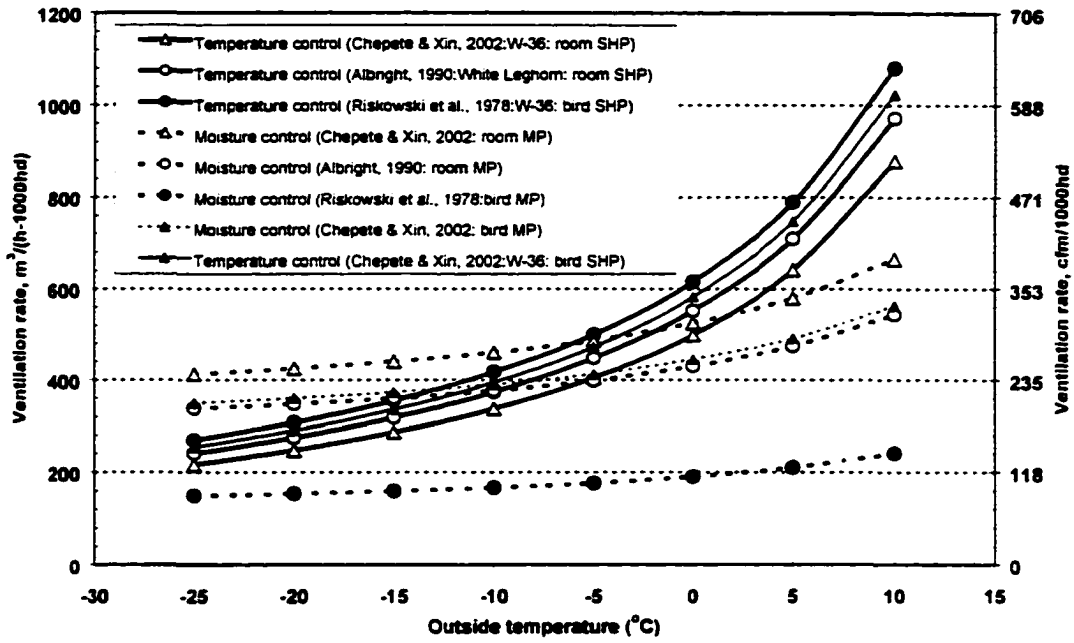


Figure 12. Ventilation graph based on outside air for temperature and moisture control at 69% stocking capacity, inside temperature of 25°C, and inside relative humidity (RH) of 50%, and outside RH of 50%. Bird MP or SHP involve moisture effect from birds only; room MP or SHP involve moisture effect from birds and surroundings.

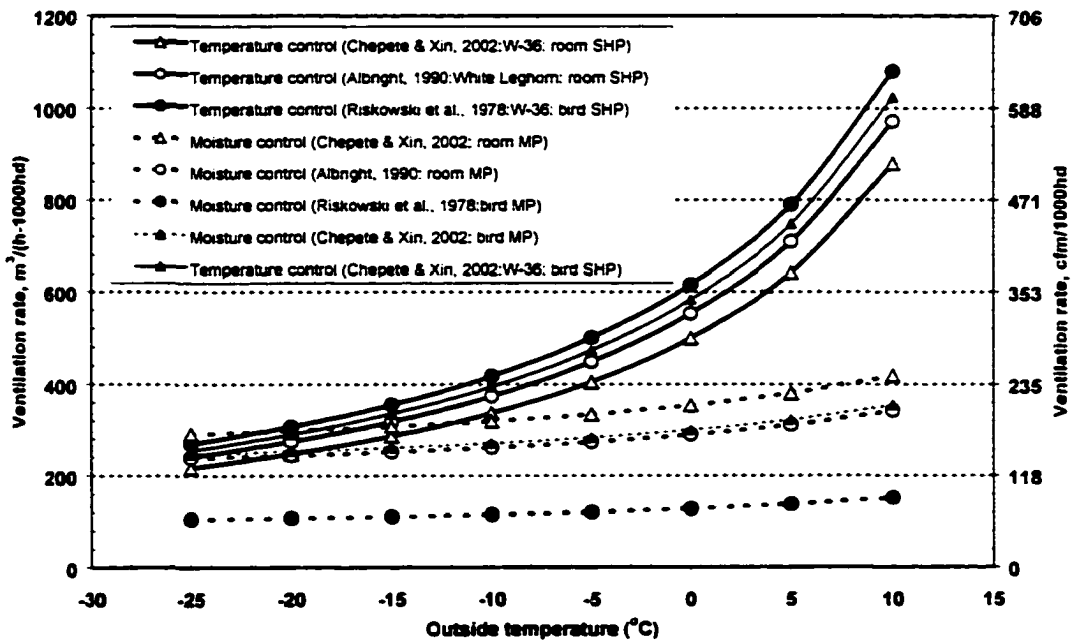


Figure 13. Ventilation graph based on outside air for temperature and moisture control at 69% stocking capacity, inside temperature of 25°C, and inside relative humidity (RH) of 70%, and outside RH of 50%. Bird MP or SHP involve moisture effect from birds only; room MP or SHP involve moisture effect from birds and surroundings.

## CHAPTER 6.

### GENERAL CONCLUSIONS

1. An extensive literature review and comparative analysis of heat and moisture production (HP, MP) of various poultry types (layers, broilers, and turkeys) and their housing systems indicated that total heat production (THP, W/kg) has increased over the years. Specifically, their increase amounted to about 21 to 44% over a 14-year period (1968 to 1982) for broilers weighing 0.1 to 1.6 kg, 15 to 22% for broilers at 1.4 to 1.6 kg over a 32-year period (1968 to 2000); and 36 to 63% over a 24-year period (1974 to 1998) for tom turkeys weighing 0.4 to 1.0 kg. Data for pullets and layers between 7- and 33- wk old at thermoneutral environment are not available. The metabolic rate equations derived from the literature data were in good agreement with the standard metabolic rate  $HP (W/bird) = a M^b$ , where  $b = 0.66$  to  $0.75$ . Specifically, it was  $8.55 M^{0.74}$  (1968) and  $10.62 M^{0.75}$  (1982 to 2000) for broilers;  $6.47 M^{0.77}$  for pullets and layers (1953 to 1990);  $7.54 M^{0.53}$  (1974 to 1977) and  $9.86 M^{0.77}$  (1992 to 1998) for turkeys.

2. HP and MP at *bird* and *room* levels of modern pullets (W-36 at 1-5 and 10 weeks of age and W-98 at 1-5 weeks of age), laying hens (W-36 at 21, 37, and 64 weeks of age), and molting hens (W-36 at 68-75 weeks of age, *room* level only) were measured using large-scale indirect calorimeters that mimic commercial production settings.

***Pullets and laying hens.*** The W-98 and W-36 pullets reached the metabolic peak at 10 and 14 days of age, respectively. The W-98 pullet produced higher THP than the W-36 counterpart. Modern pullets showed higher THP (12-37%) than those 20 to 50 years ago. At the beginning of egg production, THP of the modern layers was 12% higher than that

predicted by the CIGR (1999) model and the difference diminished with time. Evaporation of fecal moisture elevated *room* latent HP (LHP) by 8-38% (light period) or 21-79% (dark period) and reduced the *room* sensible HP (SHP) by 4-17% (light) or 14-33% (dark) with reference to *bird* LHP or SHP. All HP responses were significantly ( $P < 0.05$ ) reduced to various degrees (e.g., 23-34% for THP) in the dark as compared to the light period.

***Molting hens.*** LHP and SHP rates measured were for the *room*. THP ranged from 4.4 to 5.6 W/kg, 5.4 to 6.5 W/kg, and 6.7 to 6.9 W/kg during fasting, restricted feeding and post molt periods, respectively. LHP ranged from 1.7 to 2.1 W/kg, 1.5 to 2.0 W/kg, and 2.4 to 2.9 W/kg during the respective periods. The corresponding SHP ranged from 2.6 to 3.5 W/kg, 3.9 to 4.6 W/kg, and 3.9 to 4.4 W/kg, respectively. The corresponding respiratory quotient (RQ) averaged 0.71, 0.76, and 0.92, respectively. HP values during the light period were significantly higher ( $P < 0.05$ ) than that during the dark period. LHP as a percentage of THP ranged from 24 to 43% with no significant differences between the light and dark periods.

3. The new data for W-36 layers were used in an example of designing the building ventilation rates for a modern laying hen house in Iowa. Ventilation graphs were developed for a range of outside temperature ( $t_o$ ) of -25 to 10°C, at 5°C increments, outside relative humidity (RH) of 20 to 70%, and inside RH of 50, 60 and 70%. Comparative ventilation curves based on literature HP and MP data were also presented. The ventilation rate (VR) derived from the 'old' literature *room* sensible heat (SH) and MP data was 10% higher or 18% lower for temperature or moisture control, respectively, than that derived from the new data. Correspondingly, based on *bird* SH and MP data, VR derived from the 'old' literature data was 5% higher or 57% lower. Reducing the number of birds or stocking density by 31% to reflect the new animal welfare guidelines would slightly raise the balance temperature ( $t_{bal}$ ,

1.0 to 1.3°C), thereby having rather negligible influence on the supplemental heat requirement of the house. Increasing the room RH from 50 to 60% or from 60 to 70% reduced the ventilation rate by 17 to 61% or by 15 to 38%, respectively.

4. Results of this study provide an updated thermal load database for design and operation of poultry housing ventilation systems, as well as bioenergetics information for the scientific literature.

**APPENDIX 1.**

**CR10 PROGRAM USED IN THE STUDY**

Program:  
 Flag Usage:  
 Input Channel Usage:  
 Excitation Channel Usage:  
 Control Port Usage:  
 Pulse Input Channel Usage:  
 Output Array Definitions:

```

*      1      Table 1 Programs
01:  2      Sec. Execution Interval

01:  P10     Battery Voltage
01:  29     Loc [:Bat, Volt]

02:  P86     Do
01:  1      Call Subroutine 1 [Temp/RH readings & Heater control]

03:  P86     Do
01:  2      Call Subroutine 2 [Air sampling control]

04:  P26     Timer
01:  30     Loc [:Timer, s ]

05:  P89     If X<=>F
01:  30     X Loc Timer, s
02:  4      <
03:  301    F
04:  0      Go to end of Program Table

06:  P86     Do
01:  3      Call Subroutine 3 [Meter outputs after stabilization]

07:  P34     Z=X+F
01:  30     X Loc Timer, s
02:  -359   F
03:  31     Z Loc : Sample if >0

08:  P89     If X<=>F
01:  31     X Loc
02:  3      >=
03:  0      F
04:  10     Set high Flag 0 (output)

09:  P78     Resolution
01:  1      High Resolution

10:  P77     Real Time
01:  110    Day,Hour-Minute

11:  P71     Average
01:  10     Reprs
02:  1      Loc Temp#0
  
```

## Page 2 Table 1

12:	P71	Average
01:	8	Reps
02:	20	Loc SLP#1
13:	P70	Sample
01:	1	Reps
02:	28	Loc Sam. Seq.
14:	P89	If X<=>F
01:	31	X Loc
02:	3	>=
03:	0	F
04:	30	Then Do
15:	P26	Timer
01:	0	Reset Timer
16:	P32	Z=Z+1
01:	28	Z Loc [:Sam. Seq.]
17:	P89	If X<=>F
01:	28	X Loc Sam. Seq.
02:	3	>=
03:	5	F
04:	30	Then Do
18:	P30	Z=P
01:	0	F
02:	0	Exponent of 10
03:	28	Z Loc [:Sam. Seq.]
19:	P95	End
20:	P95	End
21:	P	End Table 1
*	2	Table 2 Programs
01:	0.0000	Sec. Execution Interval
01:	P	End Table 2
*	3	Table 3 Subroutines
		Temp/RH Measurement and Temp Control
		Temp and RH Measurement
		Heater Control Logic
		Air Sampling Control
		Analyzer and Flowmeter Output
01:	P85	Beginning of Subroutine
01:	1	Subroutine Number

## Page 3 Table 3

```

02: P11      Temp 107 Probe
01: 1       Rep
02: 1       IN Chan
03: 2       Excite all reps w/EXchan 2
04: 1       Loc [:Temp#0 ]
05: 1.8     Mult
06: 32      Offset

03: P11      Temp 107 Probe
01: 4       Reps
02: 2       IN Chan
03: 2       Excite all reps w/EXchan 2
04: 2       Loc [:Temp#1 ]
05: 1.8     Mult
06: 32      Offset

04: P4       Excite,Delay,Volt(SE)
01: 1       Rep
02: 25      2500 mV 60 Hz rejection Range
03: 6       IN Chan
04: 1       Excite all reps w/EXchan 1
05: 15      Delay (units .01sec)
06: 2500    mV Excitation
07: 6       Loc [:RH#0 ]
08: 0.1     Mult
09: 0       Offset

05: P4       Excite,Delay,Volt(SE)
01: 4       Reps
02: 25      2500 mV 60 Hz rejection Range
03: 7       IN Chan
04: 1       Excite all reps w/EXchan 1
05: 15      Delay (units .01sec)
06: 2500    mV Excitation
07: 7       Loc [:RH#1 ]
08: 0.1     Mult
09: 0       Offset

06: P87      Beginning of Loop
01: 0       Delay
02: 4       Loop Count

07: P89      If X<=>F
01: 2--     X Loc Temp#1
02: 4       <
03: 69.75  F
04: 30      Then Do

08: P30      Z=F
01: 1       F
02: 0       Exponent of 10
03: 11--    Z Loc [:Heater#1 ]

09: P95      End

```



## Page 4 Table 3

```

10: P89      If X<=>F
    01: 11--  X Loc Heater#1
    02: 2     <>
    03: 0     F
    04: 30    Then Do

11: P89      If X<=>F
    01: 2--   X Loc Temp#1
    02: 3     >=
    03: 70    F
    04: 30    Then Do

12: P30      Z=F
    01: 0     F
    02: 0     Exponent of 10
    03: 11--  Z Loc [:Heater#1 ]

13: P95      End

14: P94      Else

15: P30      Z=F
    01: 0     F
    02: 0     Exponent of 10
    03: 11--  Z Loc [:Heater#1 ]

16: P95      End

17: P95      End

18: P104     SDM-CD16
    01: 9     Reps
    02: 0     Address
    03: 11    Loc Heater#1

19: P95      End

20: P85      Beginning of Subroutine
    01: 2     Subroutine Number

21: P89      If X<=>F
    01: 28    X Loc Sam. Seq.
    02: 1     =
    03: 0     F
    04: 30    Then Do

22: P87      Beginning of Loop
    01: 0     Delay
    02: 5     Loop Count

23: P30      Z=F
    01: 0     F
    02: 0     Exponent of 10
    03: 15--  Z Loc [:Valve#0 ]

```

## Page 5 Table 3

24:	P95	End
25:	P30	Z=F
	01: 1	F
	02: 0	Exponent of 10
	03: 15	Z Loc [:Valve#0 ]
26:	P95	End
27:	P89	If X<=>F
	01: 28	X Loc Sam. Seq.
	02: 1	=
	03: 1	F
	04: 30	Then Do
28:	P87	Beginning of Loop
	01: 0	Delay
	02: 5	Loop Count
29:	P30	Z=F
	01: 0	F
	02: 0	Exponent of 10
	03: 15--	Z Loc [:Valve#0 ]
30:	P95	End
31:	P30	Z=F
	01: 1	F
	02: 0	Exponent of 10
	03: 16	Z Loc [:Valve#1 ]
32:	P95	End
33:	P89	If X<=>F
	01: 28	X Loc Sam. Seq.
	02: 1	=
	03: 2	F
	04: 30	Then Do
34:	P87	Beginning of Loop
	01: 0	Delay
	02: 5	Loop Count
35:	P30	Z=F
	01: 0	F
	02: 0	Exponent of 10
	03: 15--	Z Loc [:Valve#0 ]
36:	P95	End
37:	P30	Z=F
	01: 1	F
	02: 0	Exponent of 10
	03: 17	Z Loc [:Valve#2 ]

## Page 6 Table 3

```

38: P95      End
39: P89      If X<=>F
01: 28      X Loc Sam. Seq.
02: 1       =
03: 3       F
04: 30      Then Do
40: P87      Beginning of Loop
01: 0       Delay
02: 5       Loop Count
41: P30      Z=F
01: 0       F
02: 0       Exponent of 10
03: 15--    Z Loc [:Valve#0 ]
42: P95      End
43: P30      Z=F
01: 1       F
02: 0       Exponent of 10
03: 18      Z Loc [:Valve#3 ]
44: P95      End
45: P89      If X<=>F
01: 28      X Loc Sam. Seq.
02: 1       =
03: 4       F
04: 30      Then Do
46: P87      Beginning of Loop
01: 0       Delay
02: 5       Loop Count
47: P30      Z=F
01: 0       F
02: 0       Exponent of 10
03: 15--    Z Loc [:Valve#0 ]
48: P95      End
49: P30      Z=F
01: 1       F
02: 0       Exponent of 10
03: 19      Z Loc [:Valve#4 ]
50: P95      End
51: P104     SDM-CD16
01: 9       Reps
02: 0       Address
03: 11      Loc Heater#1

```

## Page 7 Table 3

```

52: P95      End
53: P85      Beginning of Subroutine
    01: 3     Subroutine Number
54: P86      Do
    01: 44    Set high Port 4
55: P87      Beginning of Loop
    01: 0     Delay
    02: 8     Loop Count
56: P86      Do
    01: 75    Pulse Port 5
57: P2       Volt (DIFF)
    01: 1     Rep
    02: 25    2500 mV 60 Hz rejection Range
    03: 6     IN Chan
    04: 40--  Loc [:Flow mV1 ]
    05: 1     Mult
    06: 0     Offset
58: P95      End
59: P86      Do
    01: 54    Set low Port 4
60: P37      Z=X*F
    01: 40    X Loc Flow mV1
    02: 0.6864 F
    03: 32    Z Loc :
61: P34      Z=X+F
    01: 32    X Loc
    02: -11.537 F
    03: 20    Z Loc [:SLEPM#1 ]
62: P37      Z=X*F
    01: 41    X Loc Flow mV2
    02: 0.6606 F
    03: 33    Z Loc :
63: P34      Z=X+F
    01: 33    X Loc
    02: 2.3413 F
    03: 21    Z Loc [:SLEPM#2 ]
64: P37      Z=X*F
    01: 42    X Loc Flow mV3
    02: 0.6781 F
    03: 34    Z Loc :

```

## Page 8 Table 3

65:	P34	Z=X+F	
	01: 34	X Loc	
	02: 3.1816	F	
	03: 22	Z Loc	[:SLPM#3 ]
66:	P37	Z=X*F	
	01: 43	X Loc	Flow mV4
	02: 0.6731	F	
	03: 35	Z Loc	:
67:	P34	Z=X+F	
	01: 35	X Loc	
	02: -2.7115	F	
	03: 23	Z Loc	[:SLPM#4 ]
68:	P37	Z=X*F	
	01: 44	X Loc	DP mV
	02: 0.0401	F	
	03: 36	Z Loc	:
69:	P34	Z=X+F	
	01: 36	X Loc	
	02: -39.635	F	
	03: 24	Z Loc	[:Dewpt, C ]
70:	P37	Z=X*F	
	01: 45	X Loc	CO2 mV
	02: 1.2067	F	
	03: 48	Z Loc	[:CO2, int ]
71:	P34	Z=X+F	
	01: 48	X Loc	CO2, int
	02: -10.897	F	
	03: 25	Z Loc	[:CO2, ppm ]
72:	P37	Z=X*F	
	01: 46	X Loc	O2 mV
	02: 10.104	F	
	03: 26	Z Loc	[:O2, "ppm"]
73:	P34	Z=X+F	
	01: 26	X Loc	O2, "ppm"
	02: 832.46	F	
	03: 26	Z Loc	[:O2, "ppm"]
74:	P37	Z=X*F	
	01: 47	X Loc	[BP, mV]
	02: 0.184	F	
	03: 49	Z Loc	[:BP, int ]
75:	P34	Z=X+F	
	01: 49	X Loc	BP, int
	02: 600	F	
	03: 27	Z Loc	[:BP, mbar ]

Page 9 Table 3

76: P95 End

77: P End Table 3

\* A Mode 10 Memory Allocation  
01: 50 Input Locations  
02: 64 Intermediate Locations  
03: 0.0000 Final Storage Area 2

\* C Mode 12 Security  
01: 0 LOCK 1  
02: 0 LOCK 2  
03: 0000 LOCK 3

## Page 10 Input Location Assignments (with comments):

## Key:

T=Table Number

E=Entry Number

L=Location Number

```

T:  E:  L:
3:  2:  1:  Loc [ :Temp#0  ]
3:  3:  2:  Loc [ :Temp#1  ]
3:  4:  6:  Loc [ :RH#0    ]
3:  5:  7:  Loc [ :RH#1    ]
3:  8: 11:  Z Loc [ :Heater#1 ]
3: 12: 11:  Z Loc [ :Heater#1 ]
3: 15: 11:  Z Loc [ :Heater#1 ]
3: 23: 15:  Z Loc [ :Valve#0  ]
3: 25: 15:  Z Loc [ :Valve#0  ]
3: 29: 15:  Z Loc [ :Valve#0  ]
3: 35: 15:  Z Loc [ :Valve#0  ]
3: 41: 15:  Z Loc [ :Valve#0  ]
3: 47: 15:  Z Loc [ :Valve#0  ]
3: 31: 16:  Z Loc [ :Valve#1  ]
3: 37: 17:  Z Loc [ :Valve#2  ]
3: 43: 18:  Z Loc [ :Valve#3  ]
3: 49: 19:  Z Loc [ :Valve#4  ]
3: 61: 20:  Z Loc [ :SLPM#1  ]
3: 63: 21:  Z Loc [ :SLPM#2  ]
3: 65: 22:  Z Loc [ :SLPM#3  ]
3: 67: 23:  Z Loc [ :SLPM#4  ]
3: 69: 24:  Z Loc [ :Dewpt, C ]
3: 71: 25:  Z Loc [ :CO2, ppm ]
3: 72: 26:  Z Loc [ :O2, "ppm" ]
3: 73: 26:  Z Loc [ :O2, "ppm" ]
3: 75: 27:  Z Loc [ :BP, mbar ]
1: 16: 28:  Z Loc [ :Sam. Seq. ]
1: 18: 28:  Z Loc [ :Sam. Seq. ]
1:  1: 29:  Loc [ :Bat, Volt ]
1:  4: 30:  Loc [ :Timer, s ]
1:  7: 31:  Z Loc : Sample if >0
3: 60: 32:  Z Loc :
3: 62: 33:  Z Loc :
3: 64: 34:  Z Loc :
3: 66: 35:  Z Loc :
3: 68: 36:  Z Loc :
3: 57: 40:  Loc [ :Flow mV1 ]
3: 70: 48:  Z Loc [ :CO2, int ]
3: 74: 49:  Z Loc [ :BP, int ]

```

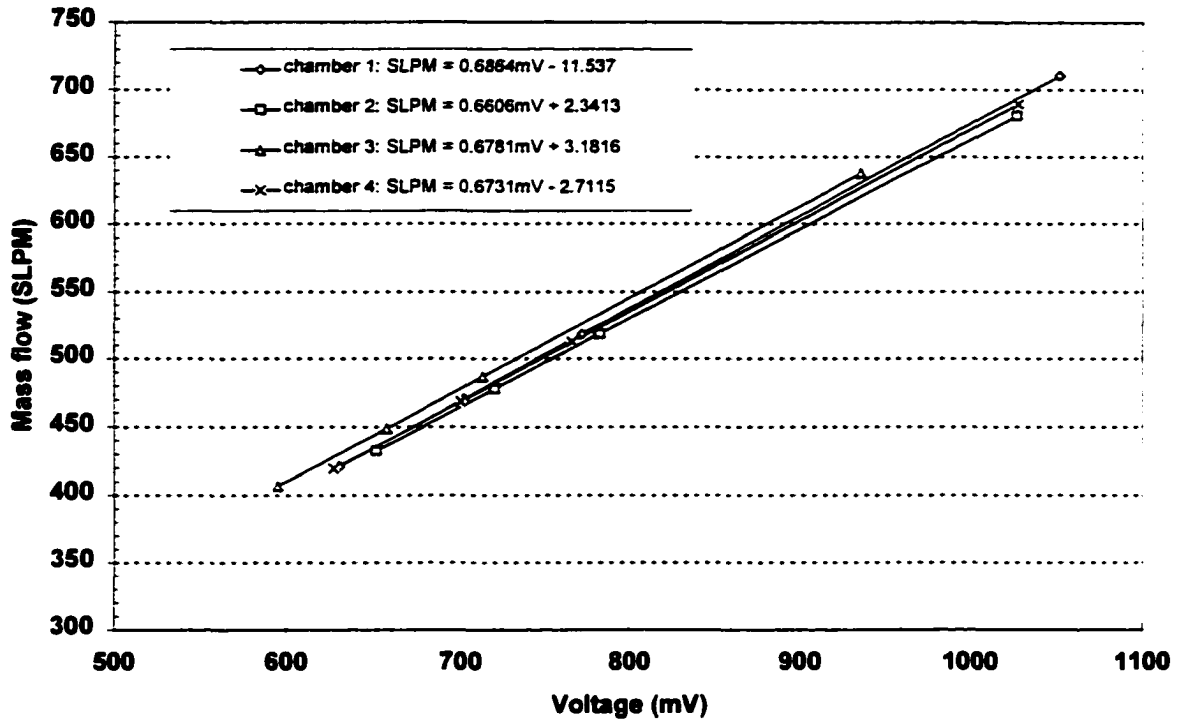
## Page 11      Input Location Labels:

1:Temp#0	14:Heater#4	27:BP, mbar	40:Flow mV1
2:Temp#1	15:Valve#0	28:Sam. Seq.	41:Flow mV2
3:Temp#2	16:Valve#1	29:Bat, Volt	42:Flow mV3
4:Temp#3	17:Valve#2	30:Timer, s	43:Flow mV4
5:Temp#4	18:Valve#3	31:_____	44:DP mV
6:RH#0	19:Valve#4	32:_____	45:CO2 mV
7:RH#1	20:SLPM#1	33:_____	46:O2 mV
8:RH#2	21:SLPM#2	34:_____	47:_____
9:RH#3	22:SLPM#3	35:_____	48:CO2, int
10:RH#4	23:SLPM#4	36:_____	49:BP, int
11:Heater#1	24:Dewpt, C	37:_____	50:_____
12:Heater#2	25:CO2, ppm	38:_____	51:_____
13:Heater#3	26:O2, "ppm"	39:_____	52:_____



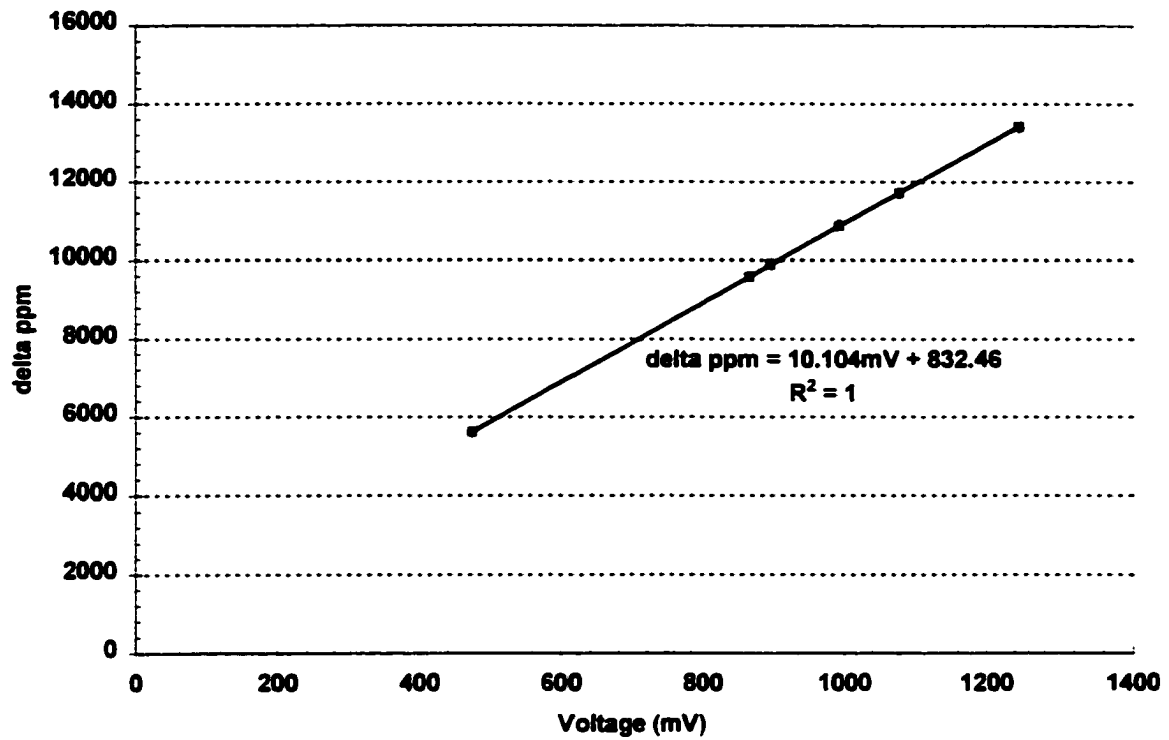
**APPENDIX 2.**

**LINEAR FUNCTIONS OBTAINED FROM CALIBRATION OF  
INSTRUMENTS**

**1. Mass flow meters (SLPM = standard liter per minute)**

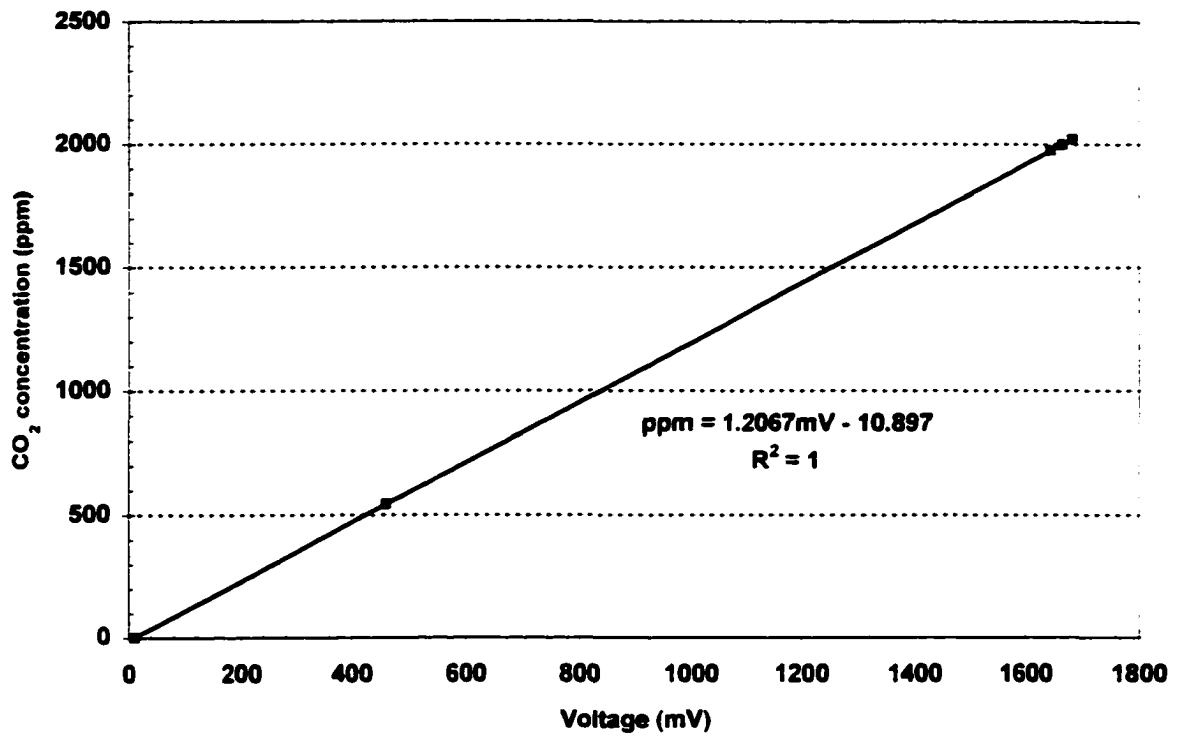
Mass flow as a function of voltage for the four calorimeter chambers.  $R^2 = 1$  for all the functions.

## 2. Oxygen analyzer



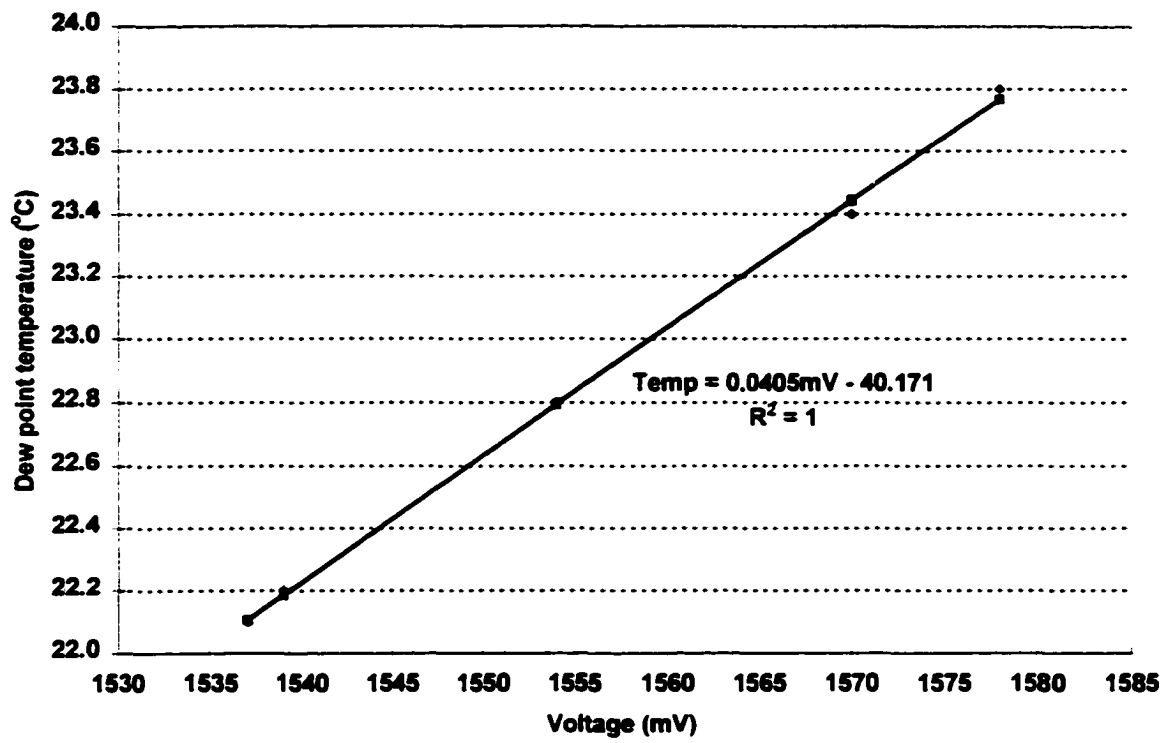
**Delta ppm as a function of voltage for the paramagnetic oxygen analyzer**

### 3. Carbon dioxide analyzer



**Carbon dioxide concentration (CO<sub>2</sub>, ppm) as a function of voltage for the CO<sub>2</sub> analyzer**

#### 4. Dew point hygrometer

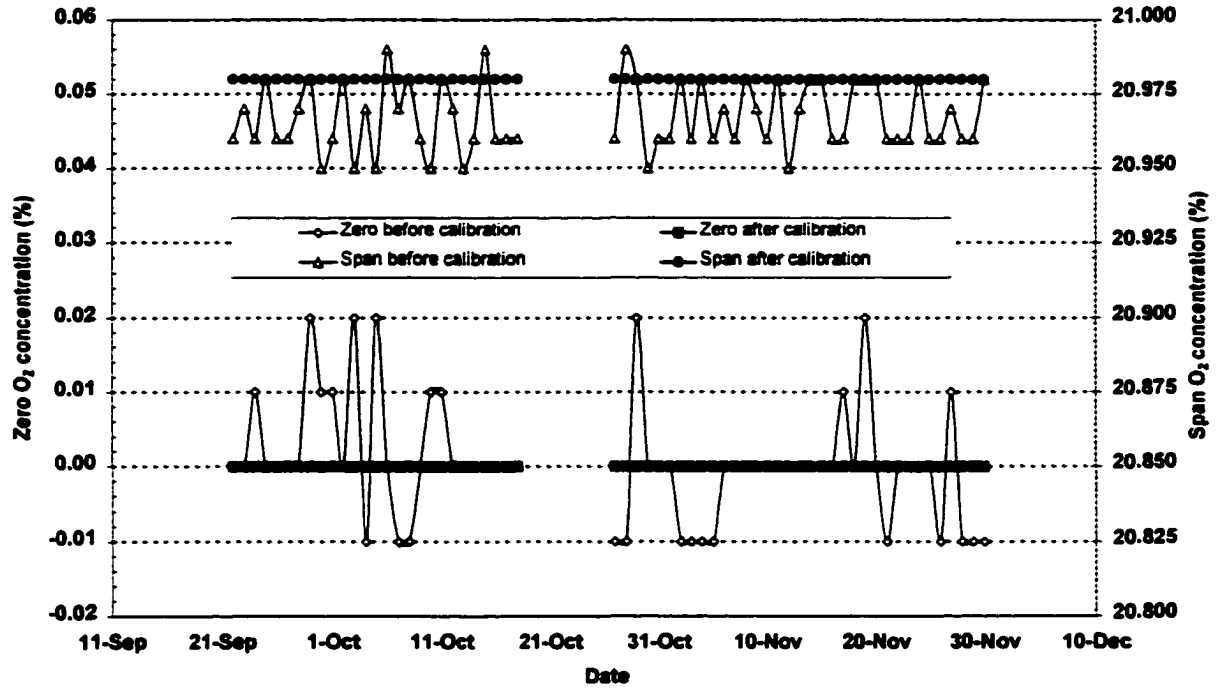


Dew point temperature as a function of voltage for the dew point hygrometer

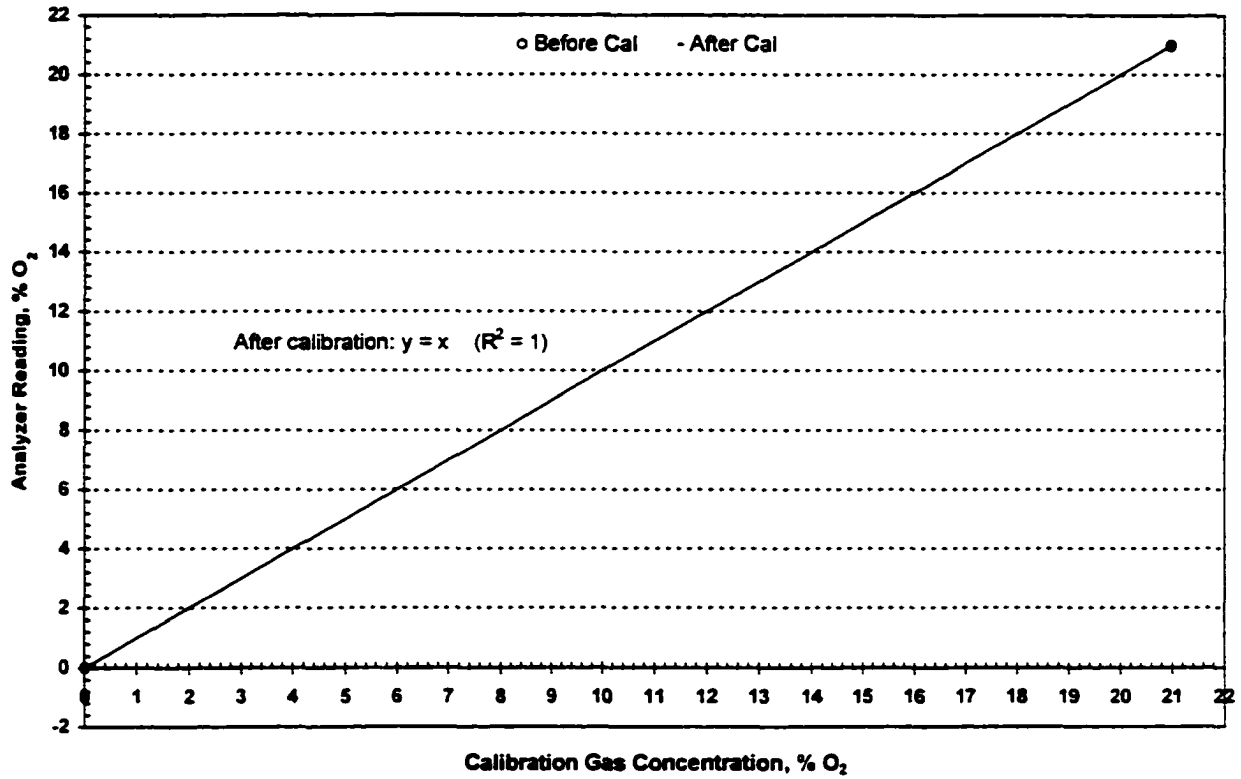
**APPENDIX 3**

**DYNAMIC BEHAVIOR OF DAILY CALIBRATION OF THE OXYGEN  
AND CARBON DIOXIDE GAS ANALYZERS DURING THE COURSE  
OF SOME TRIALS**

## 1. Oxygen analyzer



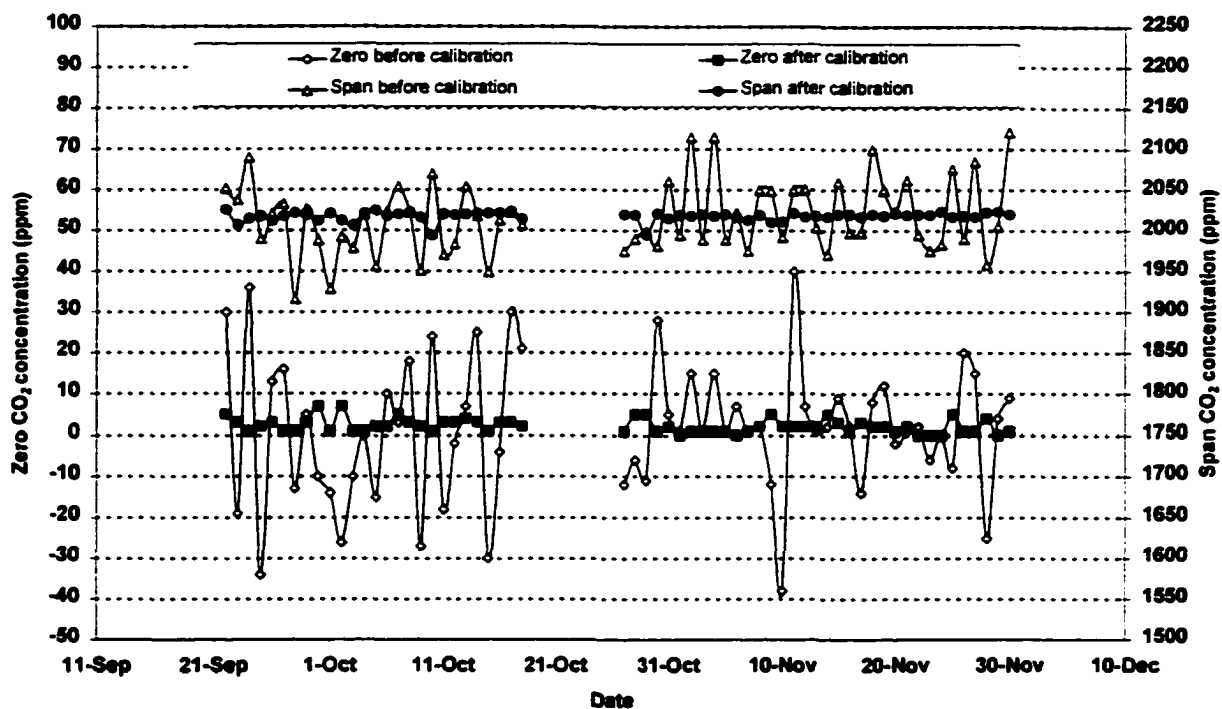
**Behavior of the oxygen (O<sub>2</sub>) analyzer during zero (99.999% nitrogen) and span (20.98% oxygen) gas calibrations during the course of experiments. The expected readings after zero and span gas calibrations were 0 and 20.89%, respectively.**

**Oxygen analyzer**

**Relationship between the analyzer readings and calibration gas or reference (0% O<sub>2</sub> for zero gas and 20.98% O<sub>2</sub> for span gas) before and after calibration during the course of experiments. The two lines overlap.**

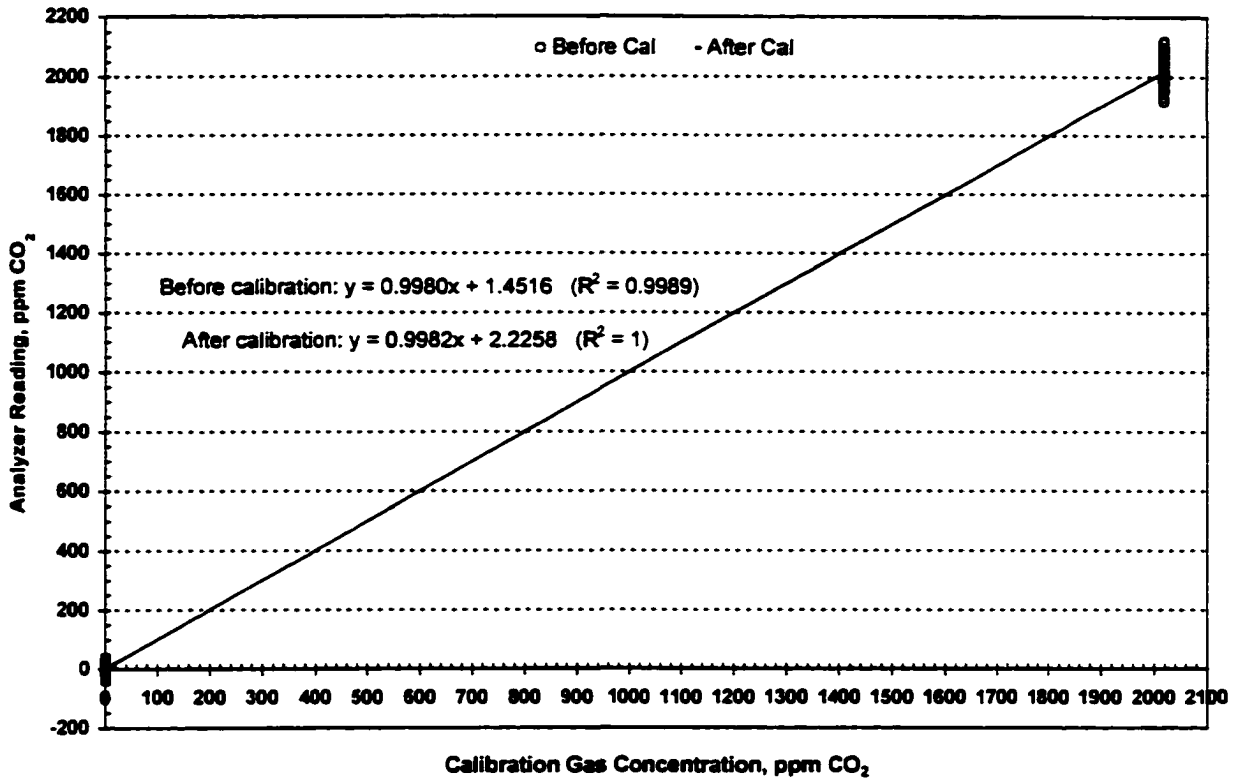


## 2. Carbon dioxide analyzer



**Behavior of the carbon dioxide (CO<sub>2</sub>) analyzer during zero (99.999% nitrogen) and span (2019 ppm CO<sub>2</sub> and nitrogen balance) gas calibrations during the course of experiments. The expected readings after zero and span gas calibrations were 0 and 2019 ppm, respectively.**

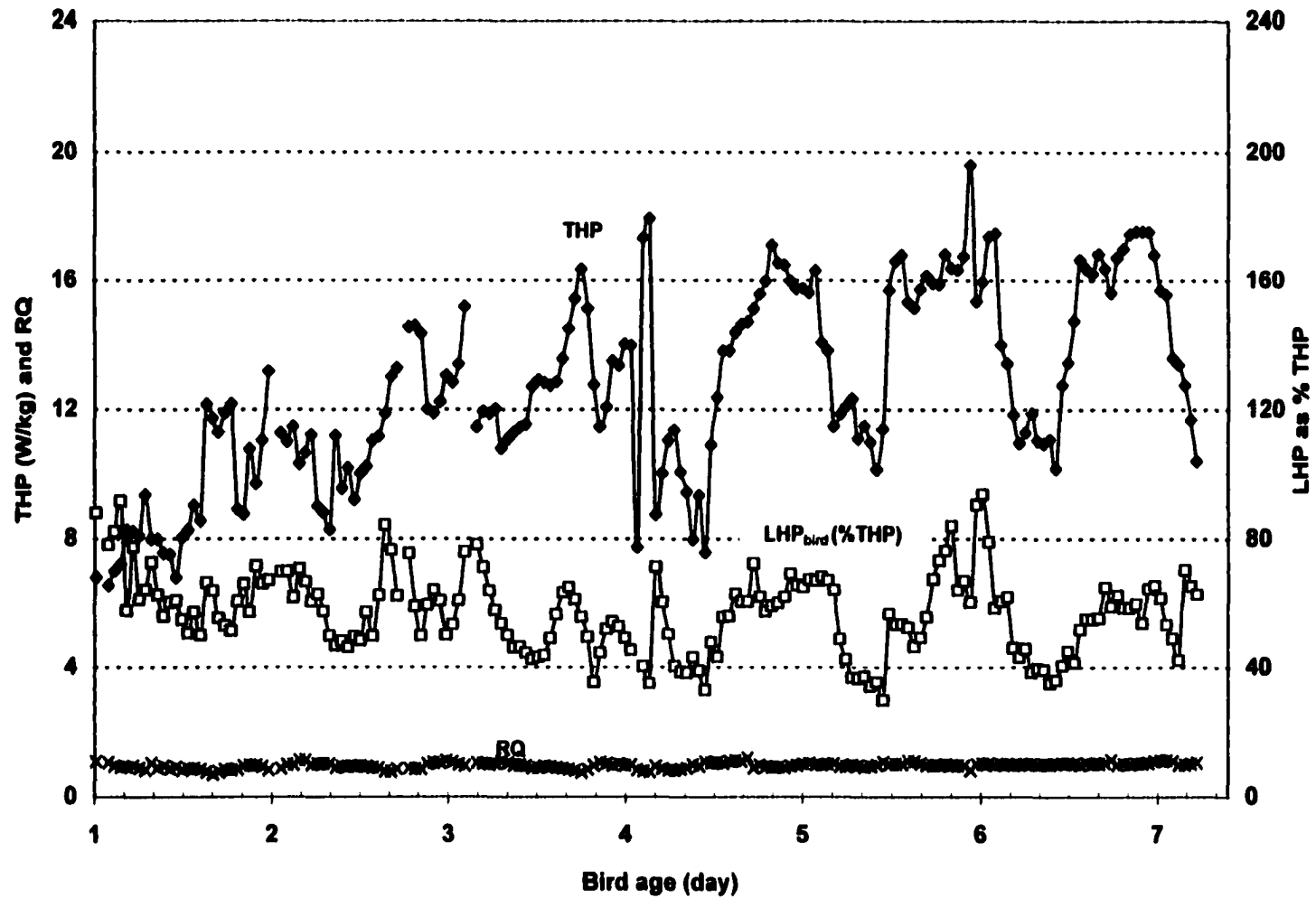
### Carbon dioxide analyzer



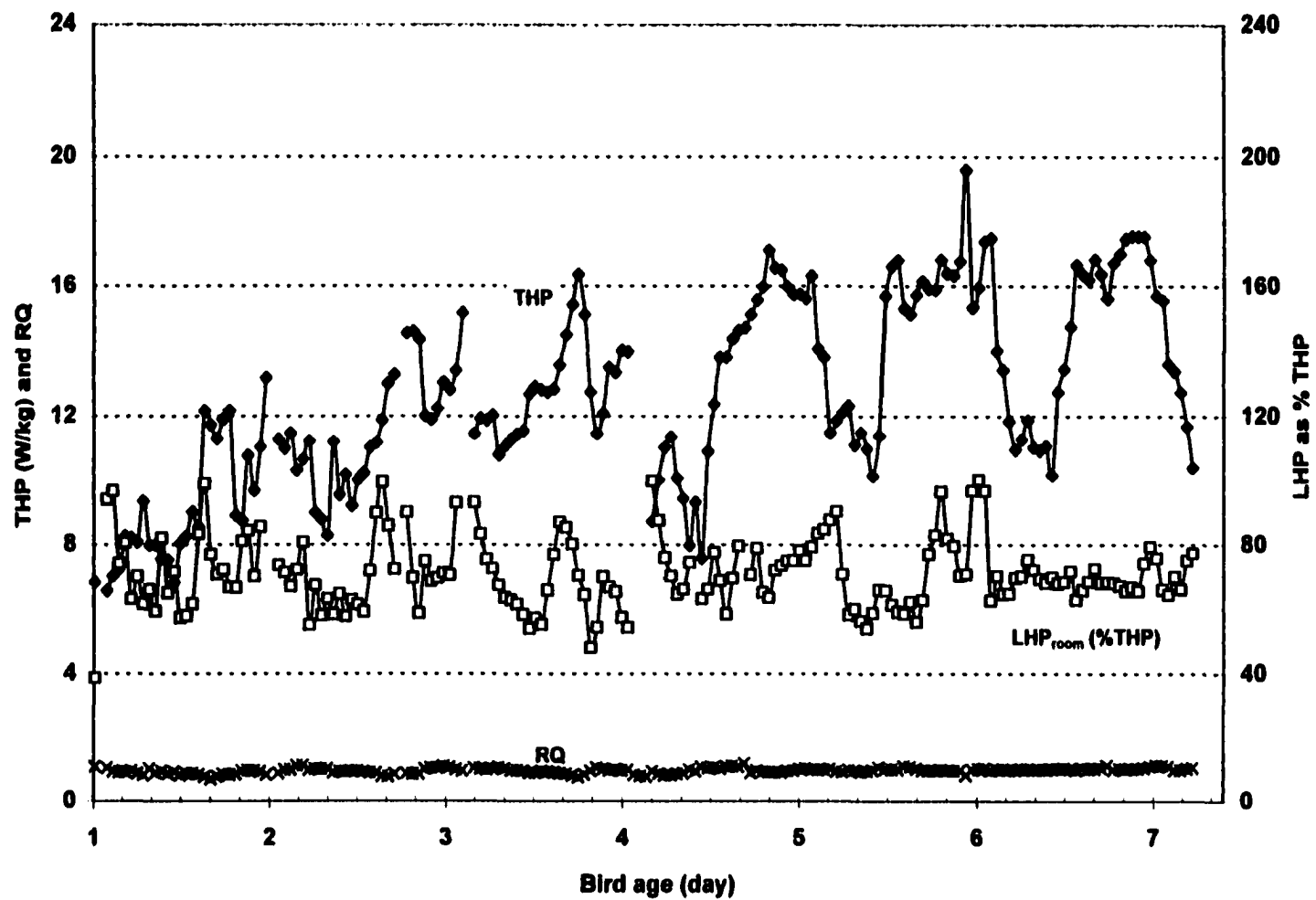
**Relationship between the analyzer readings and calibration gas or reference (0 ppm CO<sub>2</sub> for zero gas and 2019 ppm CO<sub>2</sub> for span gas) before and after calibration during the course of experiments. The two lines overlap.**

**APPENDIX 4.**

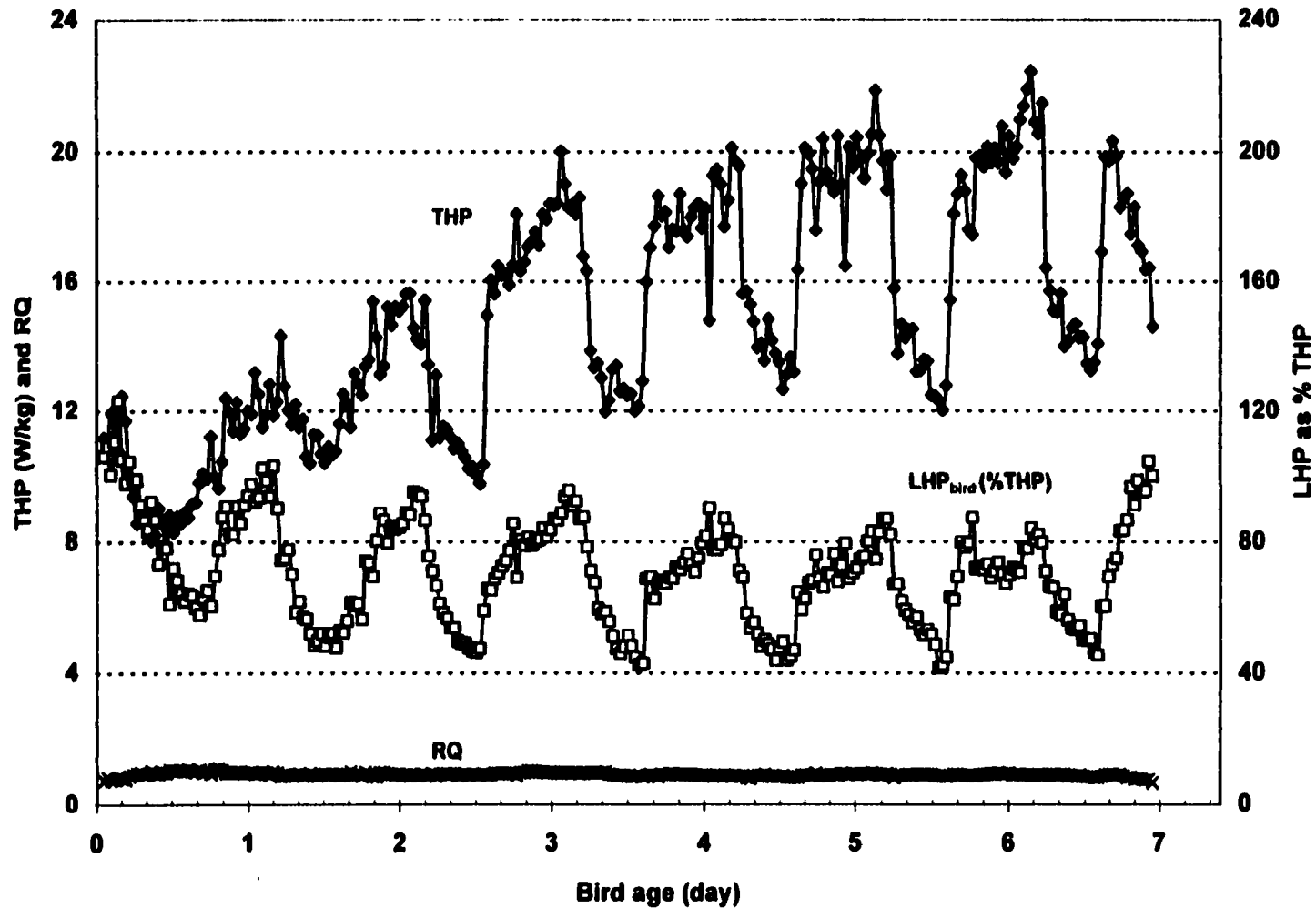
**DYNAMIC PROFILES OF HEAT AND MOISTURE PRODUCTION OF  
PULLETS AND LAYERS DURING VARIOUS SELECTED TRIALS**



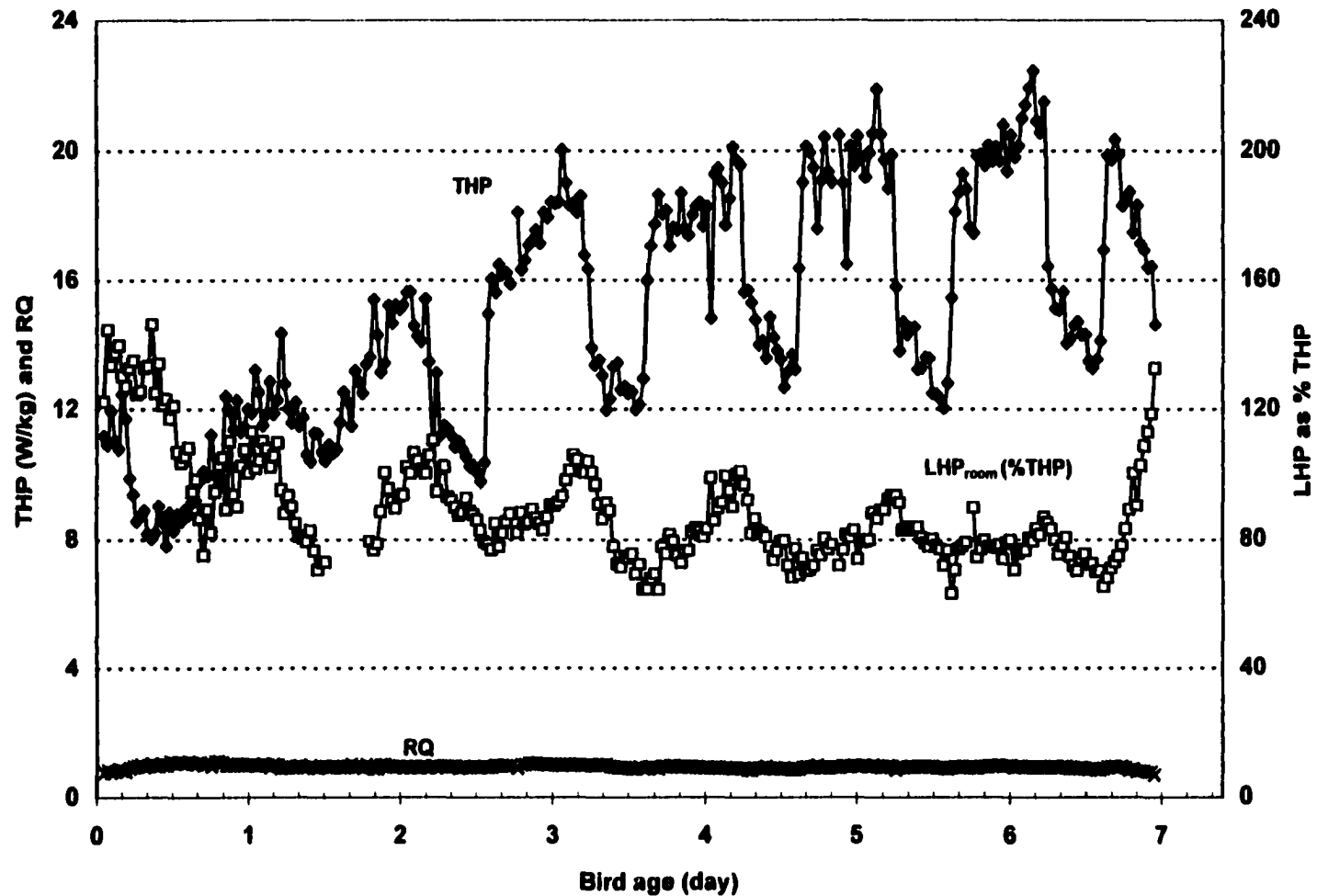
**Dynamic profiles of total heat production rate (THP), respiratory quotient (RQ), and latent heat production rate of the *bird* (LHP<sub>bird</sub>) as % THP for ad-lib fed 1-week old W-36 pullets under 30-32°C temperature and 35-50% relative humidity. Birds had water from nipple drinkers. THP and RQ are averaged over four chambers while LHP<sub>bird</sub> is averaged over two chambers.**



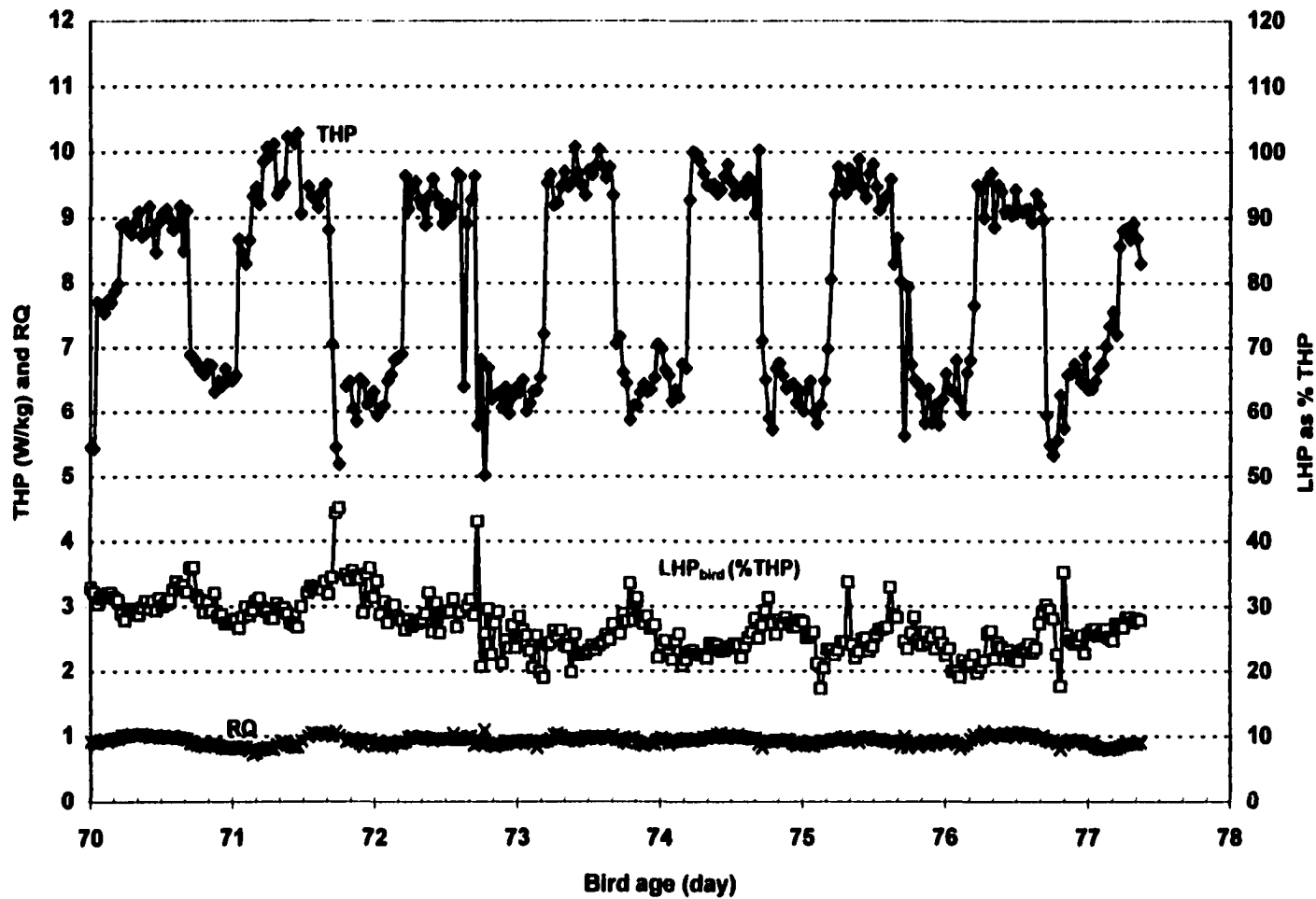
**Dynamic profiles of total heat production rate (THP), respiratory quotient (RQ), and latent heat production rate of the *room* ( $LHP_{room}$ ) as % THP for ad-lib fed 1-week old W-36 pullets under 30-32°C temperature and 35-50% relative humidity. Birds had water from nipple drinkers. THP and RQ are averaged over four chambers while  $LHP_{room}$  is averaged over two chambers.**



**Dynamic profiles of total heat production rate (THP), respiratory quotient (RQ), and latent heat production rate of the *bird* (LHP<sub>bird</sub>) as % THP for ad-lib fed 1-week old W-98 pullets under 30-32°C temperature and 35-50% relative humidity. Birds had water from nipple drinkers. THP and RQ are averaged over four chambers while LHP<sub>bird</sub> is averaged over two chambers.**

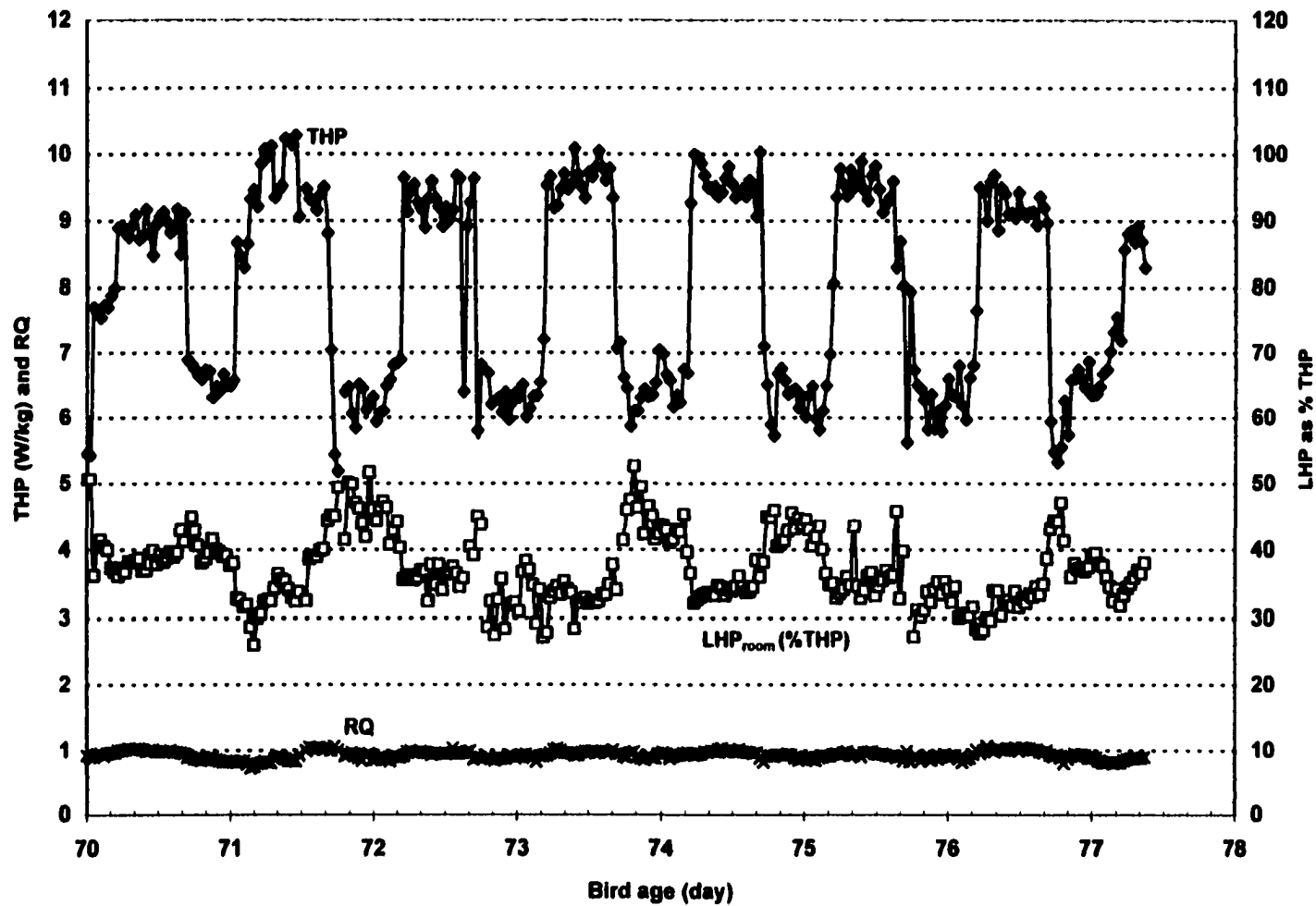


**Dynamic profiles of total heat production rate (THP), respiratory quotient (RQ), and latent heat production rate of the *room* ( $LHP_{room}$ ) as % THP for ad-lib fed 1-week old W-98 pullets under 30-32°C temperature and 35-50% relative humidity. Birds had water from nipple drinkers. THP and RQ are averaged over four chambers while  $LHP_{room}$  is averaged over two chambers.**

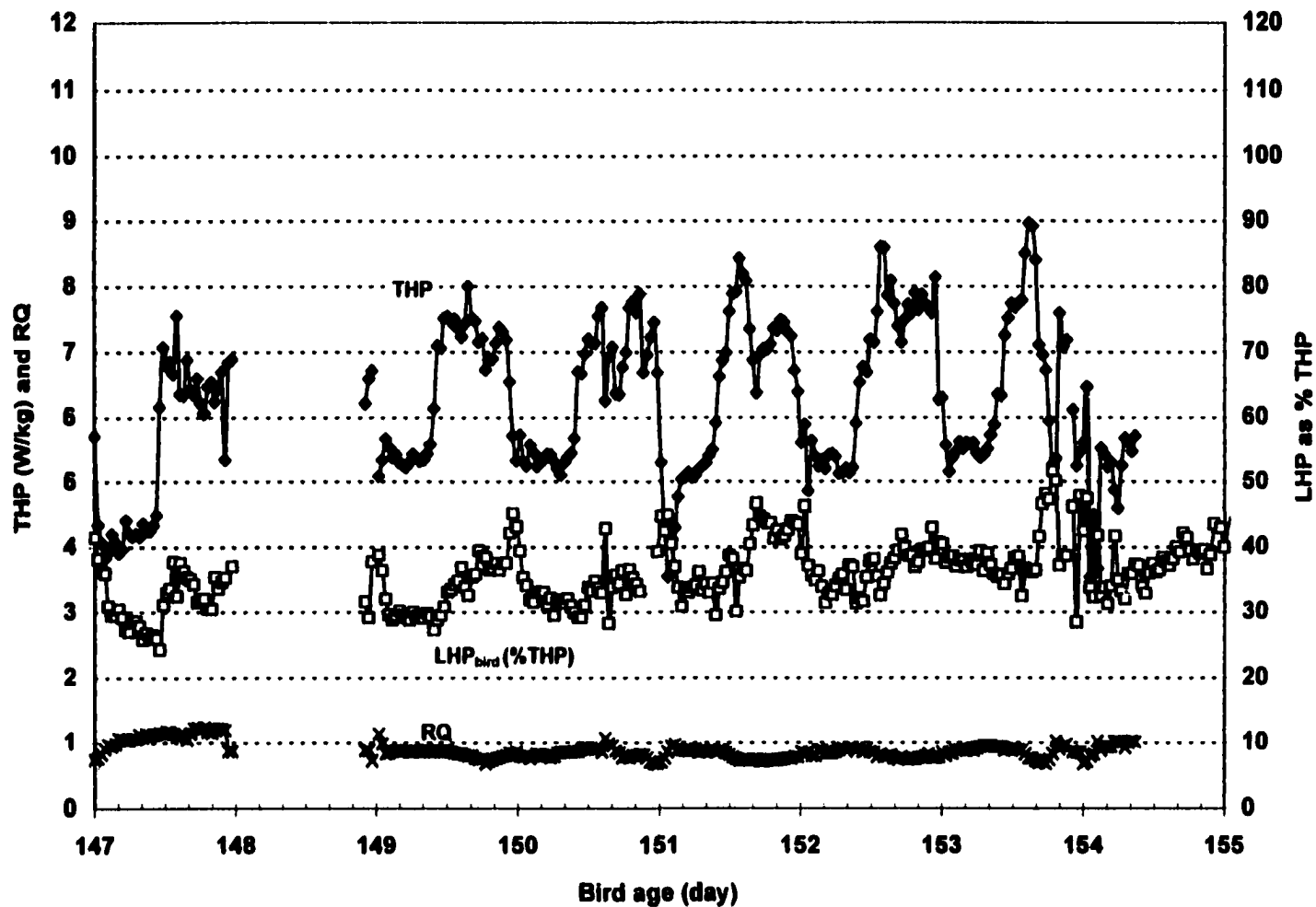


**Dynamic profiles of total heat production rate (THP), respiratory quotient (RQ), and latent heat production rate of the *bird* ( $LHP_{bird}$ ) as % THP for ad-lib fed 10-week old W-36 pullets under 21°C temperature and 35-50% relative humidity. Birds had water from nipple drinkers. THP and RQ are averaged over four chambers while  $LHP_{bird}$  is averaged over two chambers.**

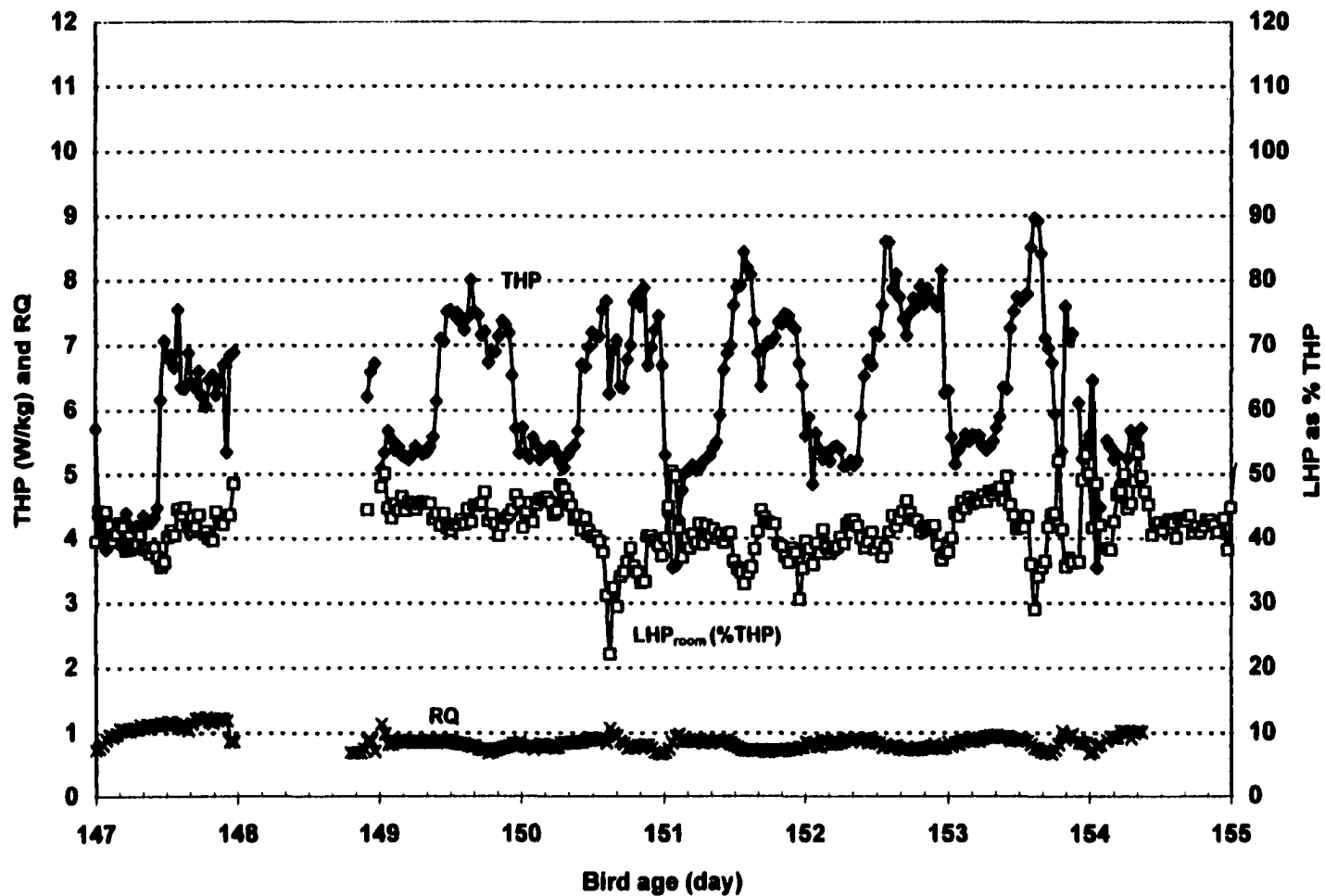




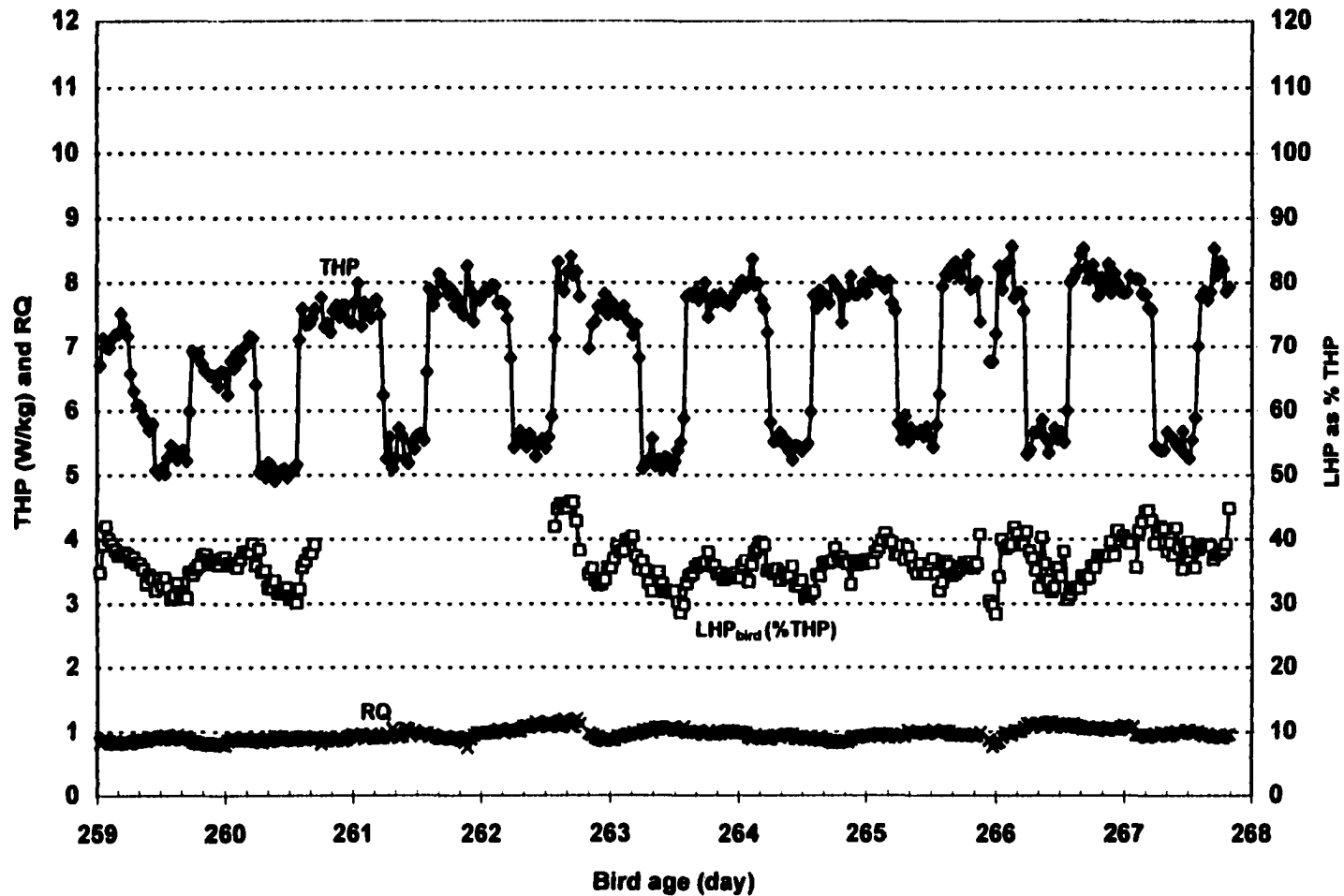
**Dynamic profiles of total heat production rate (THP), respiratory quotient (RQ), and latent heat production rate of the *room* (LHP<sub>room</sub>) as % THP for ad-lib fed 10-week old W-36 pullets under 21°C temperature and 35-50% relative humidity. Birds had water from nipple drinkers. THP and RQ are averaged over four chambers while LHP<sub>room</sub> is averaged over two chambers.**



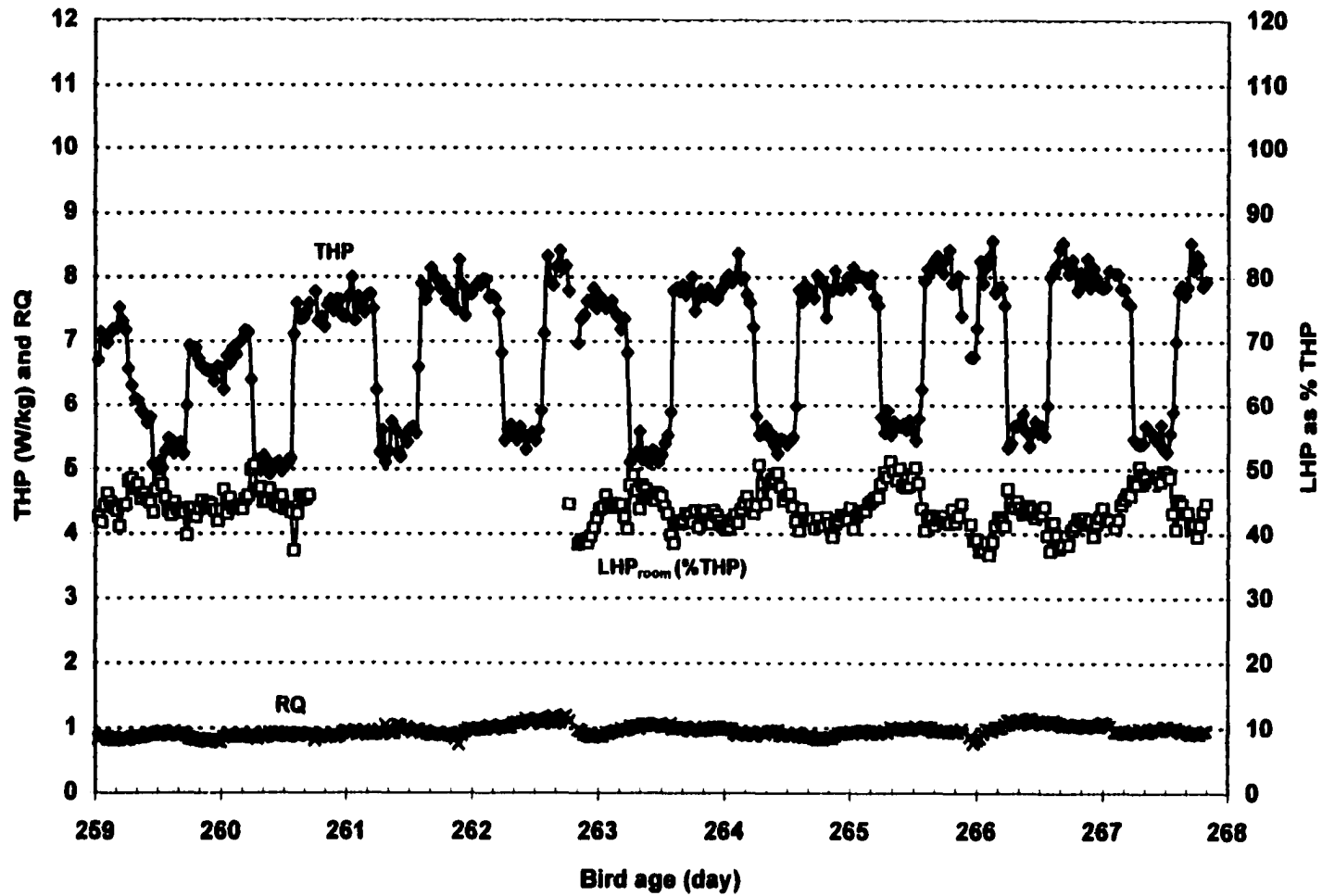
**Dynamic profiles of total heat production rate (THP), respiratory quotient (RQ), and latent heat production rate of the *bird* ( $LHP_{bird}$ ) as % THP for ad-lib fed 21-week old W-36 layers under 24°C temperature and 35-50% relative humidity. Birds had water from nipple drinkers. THP and RQ are averaged over four chambers while  $LHP_{bird}$  is averaged over two chambers.**



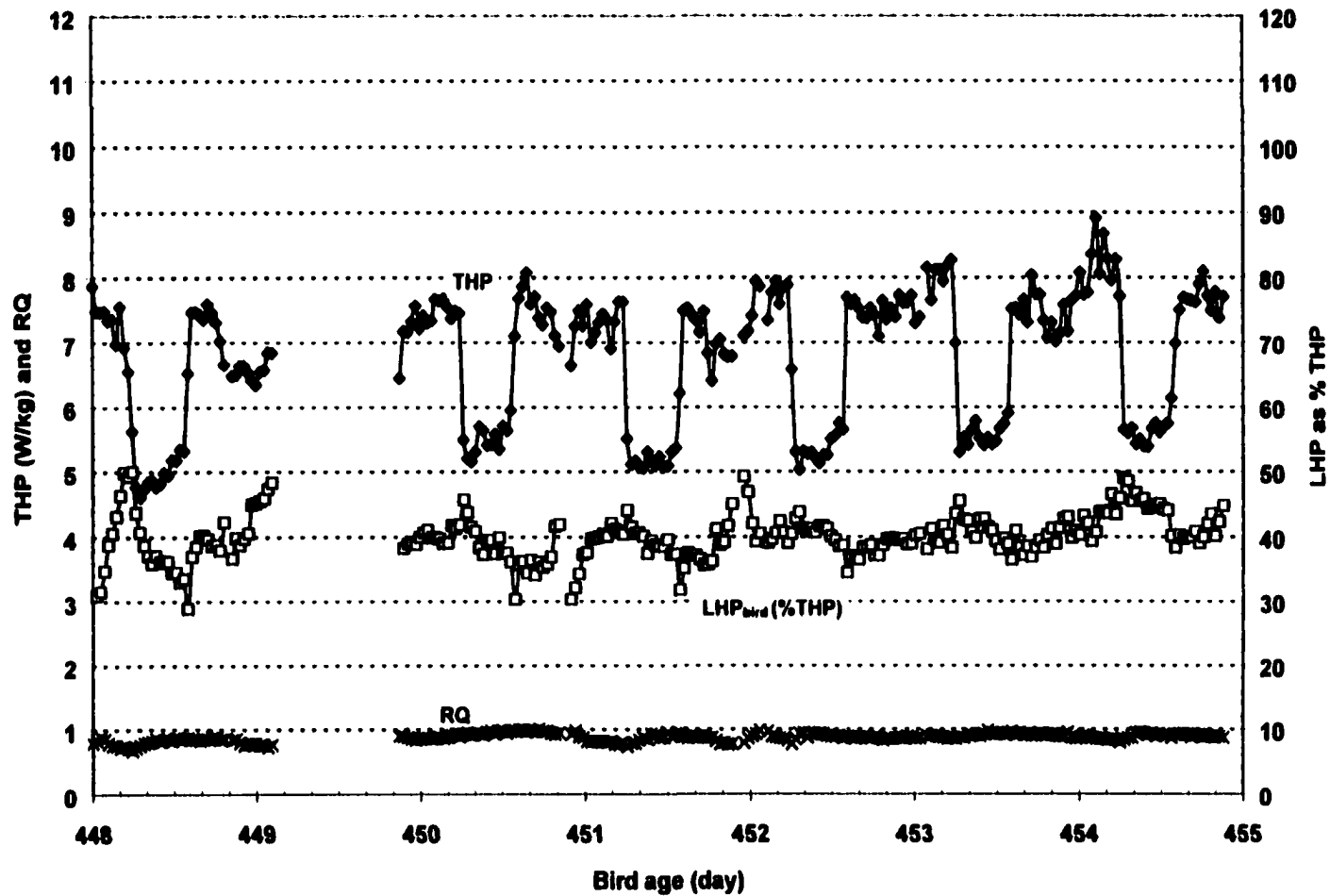
**Dynamic profiles of total heat production rate (THP), respiratory quotient (RQ), and latent heat production rate of the *room* ( $LHP_{room}$ ) as % THP for ad-lib fed 21-week old W-36 layers under 24°C temperature and 35-50% relative humidity. Birds had water from nipple drinkers. THP and RQ are averaged over four chambers while  $LHP_{room}$  is averaged over two chambers.**



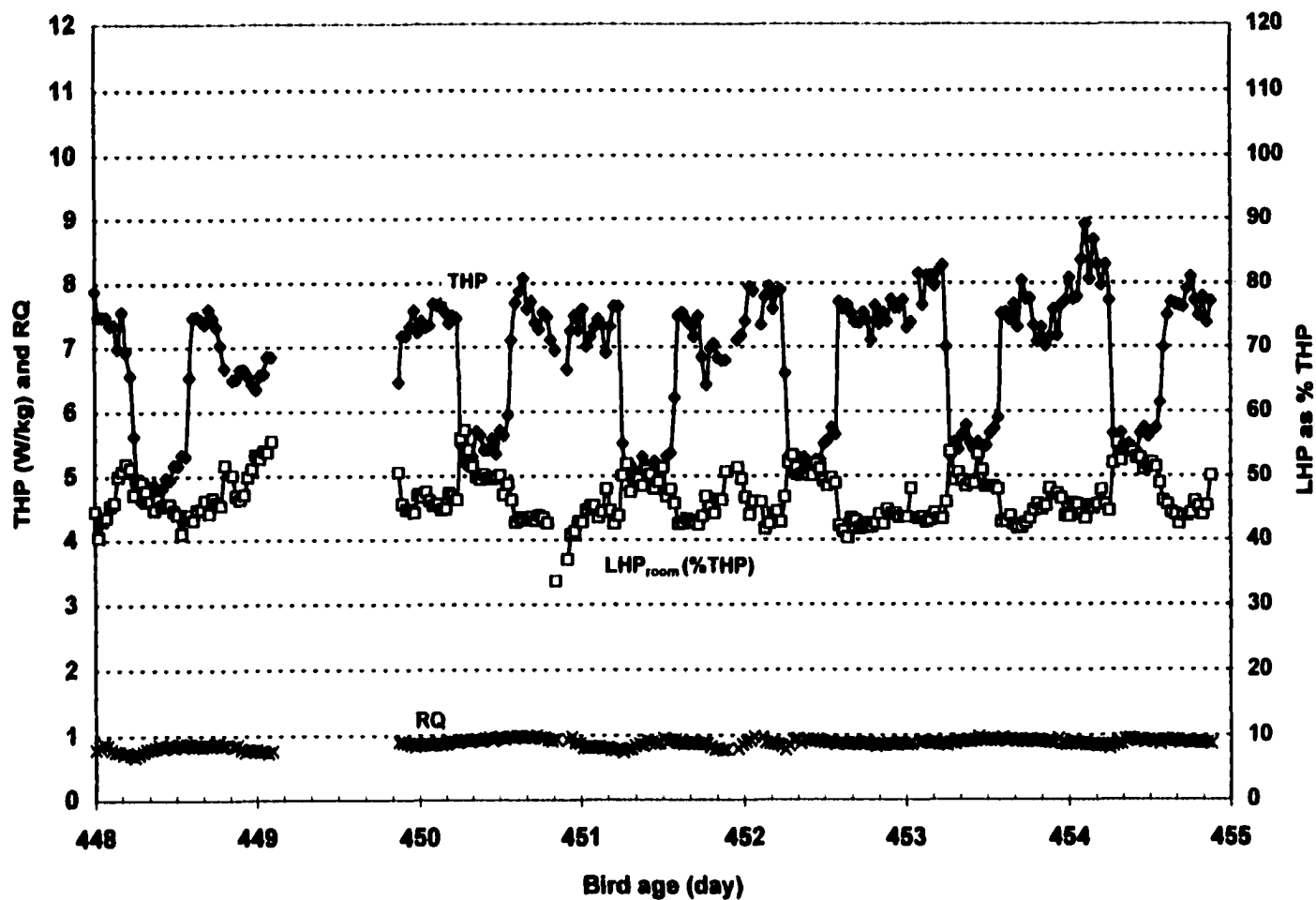
**Dynamic profiles of total heat production rate (THP), respiratory quotient (RQ), and latent heat production rate of the *bird* (LHP<sub>bird</sub>) as % THP for ad-lib fed 37-week old W-36 layers under 24°C temperature and 35-50% relative humidity. Birds had water from nipple drinkers. THP and RQ are averaged over four chambers while LHP<sub>bird</sub> is averaged over two chambers.**



**Dynamic profiles of total heat production rate (THP), respiratory quotient (RQ), and latent heat production rate of the *room* (LHP<sub>room</sub>) as % THP for ad-lib fed 37-week old W-36 layers under 24°C temperature and 35-50% relative humidity. Birds had water from nipple drinkers. THP and RQ are averaged over four chambers while LHP<sub>room</sub> is averaged over two chambers.**



**Dynamic profiles of total heat production rate (THP), respiratory quotient (RQ), and latent heat production rate of the *bird* ( $LHP_{bird}$ ) as % THP for ad-lib fed 64-week old W-36 layers under 24°C temperature and 35-50% relative humidity. Birds had water from nipple drinkers. THP and RQ are averaged over four chambers while  $LHP_{bird}$  is averaged over two chambers.**



**Dynamic profiles of total heat production rate (THP), respiratory quotient (RQ), and latent heat production rate of the *room* (LHP<sub>room</sub>) as % THP for ad-lib fed 64-week old W-36 layers under 24°C temperature and 35-50% relative humidity. Birds had water from nipple drinkers. THP and RQ are averaged over four chambers while LHP<sub>room</sub> is averaged over two chambers.**

## **AKNOWLEDGEMENTS**

Great support, inspiration and contribution from several people have enabled me to accomplish the work contained in this dissertation. I wish to express my sincere gratitude to my major professor, Dr. Hongwei Xin, for the professional guidance and friendship exercised throughout the course of my Ph.D program. He has undoubtedly empowered me with knowledge and skills through his tireless professional guidance.

I would also like to thank my entire Program of Study team who advised and guided me towards attaining quality education: Drs. Ron Nelson; Steven Hoff; Yuhong Yang and Jay Harmon. Your patience in reading this manuscript and advancing constructive suggestions is highly appreciated. I would like to thank Dr. Manuel Puma and Mr. Nelson S. Kabomo for giving me help when I needed it most during various aspects of my research work. The American Society of Heating, Refrigeration and Air-conditioning Engineers (ASHRAE) is acknowledged with gratitude for funding the research project. Farmegg Products, Humboldt, Iowa, is recognized and thanked for providing birds and feed. I cannot fail to recognize the Agricultural and Biosystems Engineering Department for giving me the opportunity to pursue my studies with Iowa State University.

Lastly, I would like to thank my fiancée, Keneilwe Tawana, for her patience throughout my studies. I would also like to thank my parents, brothers, sisters and friends, whose love and support gave me the all-time courage.